

S-2300



ENSATEC, S.L.
Pol. Ind. Lentiscares.
Avda Lentiscares 4-6
26370 NAVARRETE (LA RIOJA)
Tel. 941 25 04 66
Fax. 941 25 33 88

Certificado nº: 108949

ACREDITACIÓN



Certificado de Ensayos

Emitido a

EMPRESA: PERFILES VALENCIA, S.L.
DIRECCIÓN: CARRER DE LA POLSANA 1. P^o IND. MONCADA 2. MONCADA. VALENCIA.
PRODUCTO: VENTANA DESLIZANTE HORIZONTAL DE DOS HOJAS DERECHA.
DIMENSIONES: 1'200m x 1'200 m.
SERIE: 2300
FECHA ENSAYO: 26 de Marzo de 2003

ENSAYO DE PERMEABILIDAD AL AIRE

UNE-EN 1026:2000

CLASIFICACIÓN:

CLASE 3

ENSAYO DE ESTANQUIDAD AL AGUA

UNE-EN 1027:2000

CLASIFICACIÓN:

CLASE 5A

ENSAYO DE RESISTENCIA AL VIENTO

UNE-EN 12211:2000

CLASIFICACIÓN:

CLASE C3

Este documento no es válido sin el correspondiente informe de ensayos cuyo número coincide con el del certificado. En este informe de ensayos quedan recogidos los resultados obtenidos en cada ensayo.

Éstos sólo se refieren a la(s) muestra(s) analizada(s) por ENSATEC, S.L. en la fecha y producto arriba indicados, y pueden permitir una constancia en las prestaciones de la calidad de la producción.

Este certificado tiene una validez de un año a partir de la fecha de ensayo.



Logroño, 07 de Abril de 2004



CODIGO	FIGURA	DESCRIPCION	PESO (kg/mt)	PERIMETRO (cm)			N° CARAS	Jx mm ⁴	Jy mm ⁴
				EXT.	INT.	TOTAL			
126*		GUIA PERSIANA DE 60mm.	0.365	---	---	24.5	1	6511	51795
000231		MARCO SUPERIOR	0.816	---	---	46.5	2	26983	116976
000232		MARCO INFERIOR	0.826	32	12	49	2	22581	113386
000233		MARCO LATERAL	0.667	---	---	36.4	2	12628	108836
000234		HOJA LATERAL CRISTAL NORMAL	0.601	26	8.6	34.5	2	22035	55485
000235		HOJA CENTRAL CRISTAL NORMAL	0.579	22.4	10.5	32.9	2	23822	44917
000236		HOJA RODAMIENTOS CRISTAL NORMAL	0.536	---	---	30.8	2	15223	45111
000237		ZOCALO CRISTAL NORMAL	1.029	40.5	15	55.5	2	29397	331646
000238		FIJO SIN CLIP	0.680	---	---	37.3	2	19695	96766
000239		FIJO CON CLIP	0.495	---	---	28	2	11037	61686
763*		GUIA PERSIANA DE 40mm.	0.275	---	---	18.7	1	4283	20141
764*		GUIA PERSIANA DE 45mm.	0.309	---	---	21	1	5843	25207
01003		GUIA PERSIANA PALA 120mm.	0.947	43.2	9.9	53.2	1	54836	443832





* SEGÚN NECESIDADES

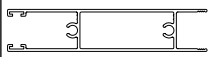

CODIGO	FIGURA	DESCRIPCION	PESO (kg/mt)	PERIMETRO (cm)			N° CARAS	Jx mm ⁴	Jy mm ⁴
				EXT.	INT.	TOTAL			
01004		GUIA PERSIANA PALA 120mm.	0.947	43.2	9.9	53.2	1	63809	482212
01036		DOBLE GUIA PERSIANA	1.005	43.3	16.8	60.2	2	33385	391321
01040		GUIA PERSIANA 45mm.	0.345	---	---	23.4	1	7021	29406
01071		GUIA PERSIANA PALA 120mm. CON RECOGEDOR	1.188	54	10.2	64.3	1	102040	861655
1073*		SOLAPE SUPERIOR	0.200	---	---	12	1	730	9160
02313		MARCO SUPERIOR 3 CARRILES	1.405	61.1	5.3	66.4	2	47331	467536
02323		MARCO INFERIOR 3 CARRILES	1.548	47	27.7	74.7	2	47694	477080
002330		MARCO LATERAL CON TAPA	0.761	---	---	41.1	2	16457	126185
002331		TAPA PARA MARCO LATERAL	0.123	---	---	9.1	1	318	5488
02333		MARCO LATERAL 3 CARRILES	1.063	---	---	52.6	2	19584	445037
002340		HOJA LATERAL CRISTAL CAMARA	0.571	24.3	8.6	32.9	2	21468	47912
002350		HOJA CENTRAL CRISTAL CAMARA	0.550	26.7	10.5	31.2	2	23215	38575
002360		HOJA RODAMIENTOS CRISTAL CAMARA	0.501	---	---	29.5	2	14452	37604

* SEGÚN NECESIDADES

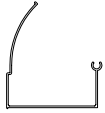
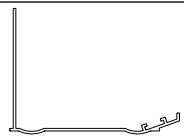
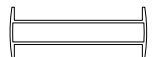
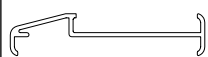
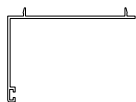
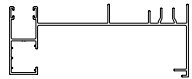

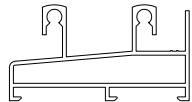
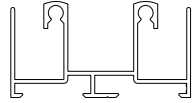
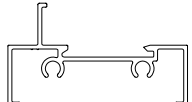





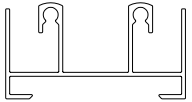

CODIGO	FIGURA	DESCRIPCION	PESO (kg/mt)	PERIMETRO (cm)			N° CARAS	Jx mm ⁴	Jy mm ⁴
				EXT.	INT.	TOTAL			
002370		ZOCALO CRISTAL CAMARA	0.992	39.2	15	54.1	2	28599	300348
3207*		GUIA PERSIANA PALA 120mm. CON RECOGEDOR	1.057	---	---	61.5	1	91662	792056
3215*		ESQUINERO REGULABLE MONOBLOCK MACHO	2.133	---	---	72.4	2	1180370	2258364
3216*		ESQUINERO REGULABLE MONOBLOCK HEMBRA	2.090	---	---	70.1	2	1095195	2030794
4215*		SOLAPE DE 85mm.	0.564	---	---	32	1	41043	210454
4656*		UNION MARCOS	0.659	20.8	14.9	35.7	2	8890	140306
4803*		PERFIL BANDERA	0.374	---	---	19.5	3	1095	68706
10961*		SOLAPE DE 43mm.	0.383	---	---	24.4	1	15444	76817
10962*		MARCO LATERAL CON GUIA PERSIANA 140mm.	1.495	---	---	76.5	2	125628	1554535
10963*		MARCO LATERAL CON GUIA PERSIANA 140mm.	1.495	---	---	76.5	2	126531	1472168
23001		MARCO INFERIOR	0.853	33.1	13	46.1	2	28003	112930
23002		MARCO SUPERIOR	0.804	---	---	43.7	2	30466	115095
23010		MARCO FIJO SIN CLIP	0.572	---	---	31	2	9053	91369

* SEGÚN NECESIDADES

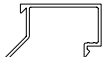
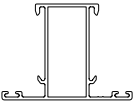
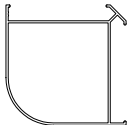

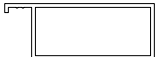
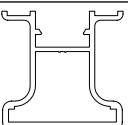
CODIGO	FIGURA	DESCRIPCION	PESO (kg/mt)	PERIMETRO (cm)			N° CARAS	Jx mm ⁴	Jy mm ⁴
				EXT.	INT.	TOTAL			
23011		MARCO FIJO CON CLIP	0.403	---	---	22.4	2	2805	58398
23015		MARCO LATERAL	0.649	---	---	37	2	12749	113335
23027		MARCO LATERAL	0.668	---	---	36.8	2	11849	132474
23034		MARCO FIJO PERIMETRAL	0.824	28.1	16.6	44.7	2	32109	114650
23035		ESQUINERO REGULABLE	0.441	---	---	23.9	2	6060	78324
23036		MARCO LATERAL CON GUIA PERSIANA 120mm.	1.422	---	---	73.2	2	122305	997230
23037		MARCO LATERAL CON GUIA PERSIANA 120mm.	1.422	---	---	73.2	2	121173	1061360
23061		DIVISOR	0.496	---	---	28.2	2	11544	37792
23094		ESQUINERO CORREDERA-ABISAGRADA	0.962	29.7	21	50.8	3	140892	258826
23100	PREMARCO 50 mm. ESPESOR 1.1 mm	0.373	14	10.9	24.9		7997	33947	
23101		MARCO SUPERIOR	0.741	---	---	40.2	2	26369	114637
23102		MARCO INFERIOR	0.776	31.3	13.1	44.4	2	24957	105529
23121		MARCO INFERIOR	0.728	---	---	35.5	2	22052	104507

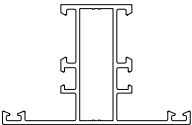

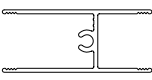
CODIGO	FIGURA	DESCRIPCION	PESO (kg/mt)	PERIMETRO (cm)			N° CARAS	Jx mm ⁴	Jy mm ⁴
				EXT.	INT.	TOTAL			
23124		MARCO SUPERIOR	0.772	---	---	41.2	2	27107	123270
42008		JUNQUILLO PARA HUECO 21mm.	0.195	---	---	14.2	2	2079	6545
42010		JUNQUILLO PARA HUECO 9.5mm.	0.194	---	---	14.1	2	2590	8415
42203		TRAVESAÑO	0.609	25.5	10.7	36.2	2	36230	53420
72011		ESQUINERO 90°	1.111	25.9	18	58.5	3	280476	329897
72012		UNION DE MARCOS	0.351	---	---	20.2	2	1112	76100
72014		PREMARCO 50 mm. ESPESOR 1.25 mm	0.424	14.1	10.9	25	-	9242	38778
80012		PERFIL REFUERZO	0.854	22.2	11.4	33.6	3	59657	48491
80013		GRAPA PERFIL REFUERZO	0.133	---	---	7.4	-	506	1507
94103		TRAVESAÑO VENTANA	0.747	31.8	9.8	41.5	2	50631	56547
94301		JUNQUILLO PARA HUECO 12mm.	0.225	---	---	16.4	2	4968	6272
94302		JUNQUILLO PARA HUECO 18mm.	0.205	---	---	15	2	3403	4989
700062		DIVISOR CRISTAL CAMARA	0.454	---	---	26.1	2	12762	25612



CODIGO	FIGURA	DESCRIPCION	PESO (kg/mt)	PERIMETRO (cm)			N° CARAS	Jx mm ⁴	Jy mm ⁴
				EXT.	INT.	TOTAL			
700083		MARCO FIJO 3 CARRILES	1.321	34.9	28.7	63.6	3	50098	443865
700101		SOLAPE DE 33mm.	0.199	---	---	11.7	1	626	11977
700102		SOLAPE DE 43mm.	0.234	---	---	13.7	1	721	22263
700103		SOLAPE DE 60mm.	0.332	---	---	17.3	1	977	54828
700104		SOLAPE DE 87mm.	0.443	---	---	22.8	1	1134	141429
700108		SOLAPE CURVO DE 60mm.	0.428	---	---	21.4	1	3631	67311
700141		PERFIL 4 HOJAS	0.341	---	---	18.3	1	3889	8412
E-0245		PREMARCO DE 120mm.	0.773	30.2	7.9	38.1		9654	394698
H-955*		DOBLE GUIA	1.358	29.4	20.8	50.1	3	129003	268492
S/M-2300*		SUPLEMENTO MOSQUITERA	0.201	---	---	8.4	1	164	6296

* SEGÚN NECESIDADES



CODIGO	FIGURA	DESCRIPCION	CODIGO	FIGURA	DESCRIPCION
03.07.06		BURLETE 7x6	23.01.40		KIT ACCESORIOS S-2300 3 CARRILES RUEDAS NYLON
F3.07.06		BURLETE 7x6 FIN-SEALE	23.02.01		CIERRE COMBI ACCION VERTICAL
23.01.10		KIT ACCESORIOS S-2300 RUEDAS ZAMAC	23.02.02		JUEGO ASA TIRADOR
23.01.11		JUEGO JUNTAS MARCOS	23.02.03		ESCUADRA PREMARCO 72014
23.01.12		JUEGO 4 PRESILLAS Y 2 TAPAS	23.03.03		GOMA HOJA LATERAL FLEXIBAND 3x20
23.01.13		JUEGO CORTAVIENTOS	23.10.01		TROQUEL MANUAL-PRENSA S-2300
23.01.14		VALVULA DESAGÜE MARCO INFERIOR	23.10.02		TROQUEL NEUMATICO S-2300
23.01.15		RUEDA S-2300 ZAMAC	23.10.03		TROQUEL MANUAL-PRENSA HOJAS NUEVAS
23.01.20		KIT ACCESORIOS S-2300 RUEDAS NYLON	23.10.07		TROQUEL MANUAL-PRENSA CIERRE EMBUTIDO S-2300
23.01.21		RUEDA S-2300 NYLON	23.10.08		TROQUEL NEUMATICO CIERRE EMBUTIDO S-2300
23.01.30		KIT ACCESORIOS S-2300 3 CARRILES RUEDAS ZAMAC	23.10.09		TROQUEL MANUAL-PRENSA MARCOS 3 CARRILES S-2300
23.01.31		JUEGO JUNTAS MARCOS 3 CARRILES S-2300	23.10.10		TROQUEL NEUMATICO MARCOS 3 CARRILES S-2300
			42.20.01		UNION TRAVESAÑO 42201 S-4220

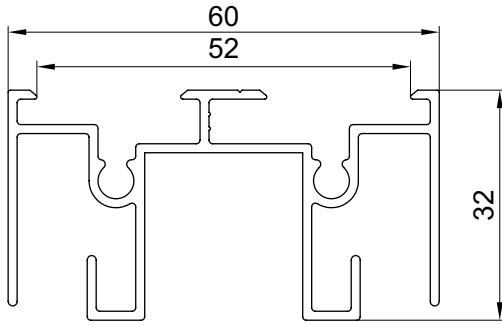

000231

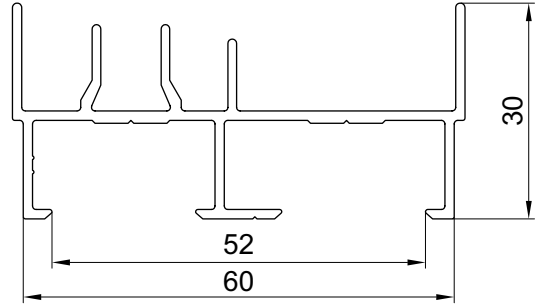

000233

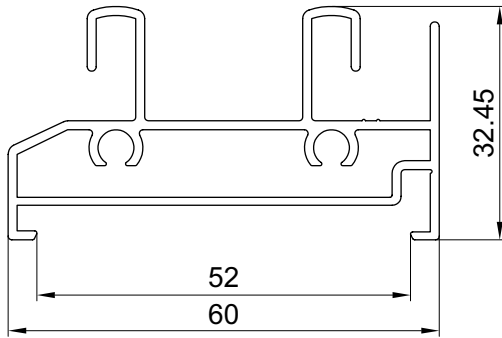

000232

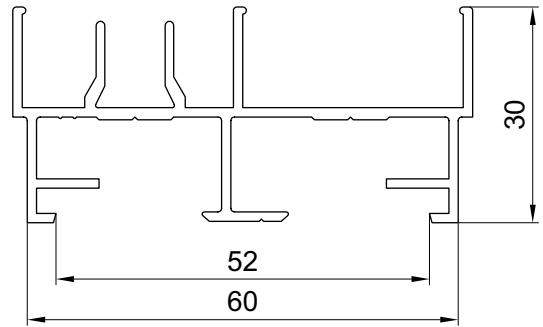

002330

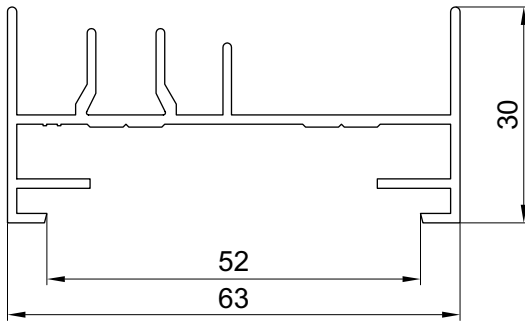

23027

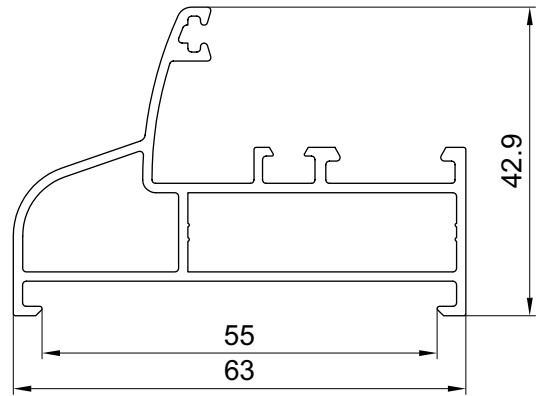

23034

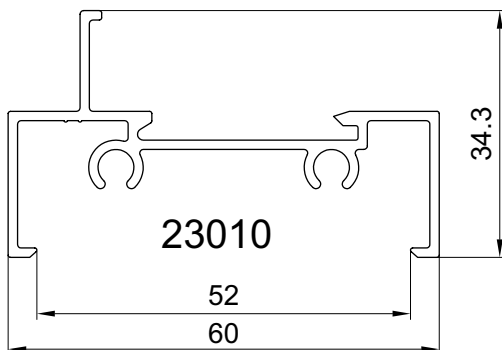

23010

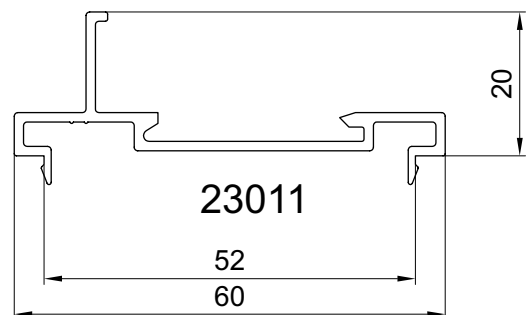

23011

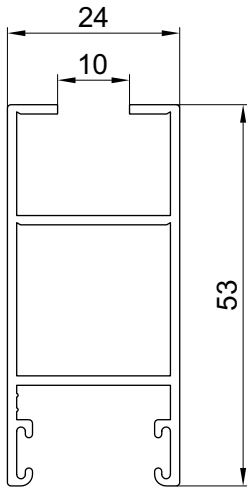

000234

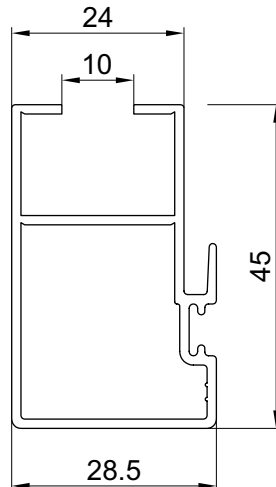

000235

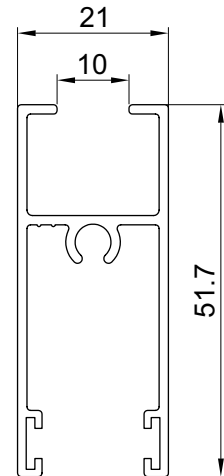

000236

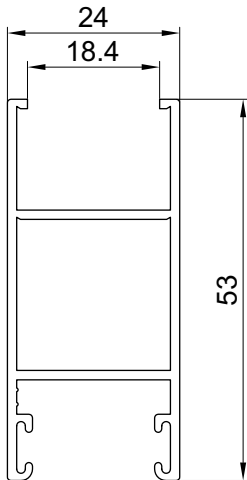

002340

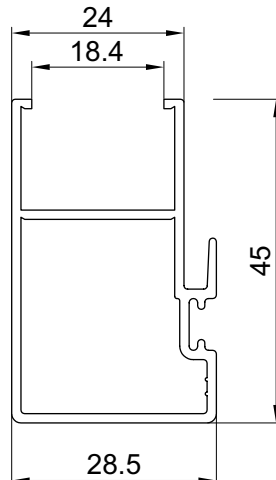

002350

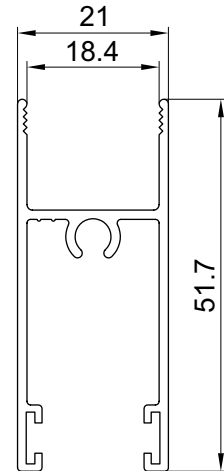

002360

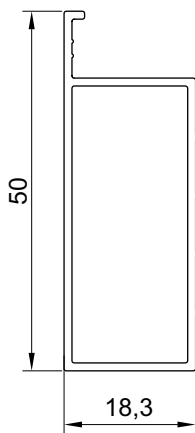

23100

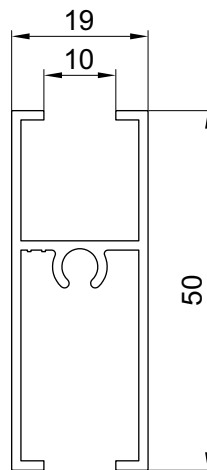

23061

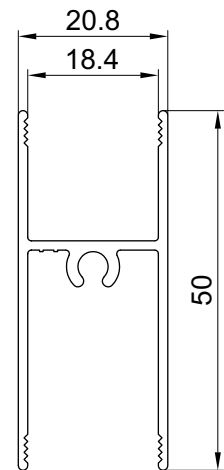

700062

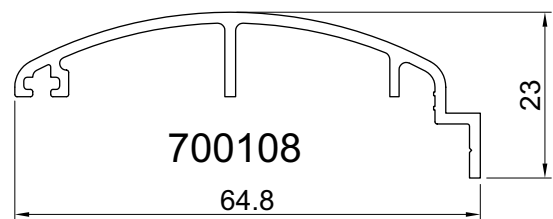
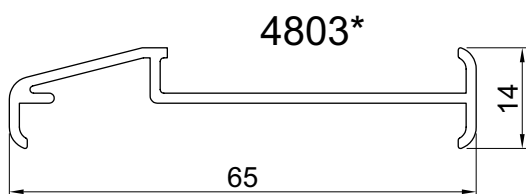
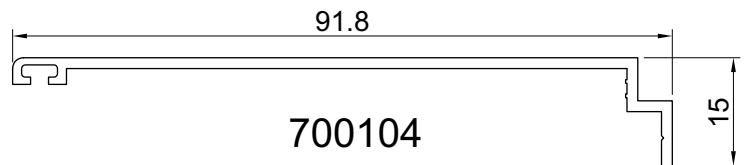
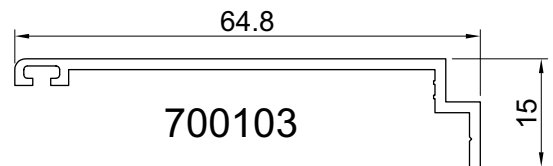
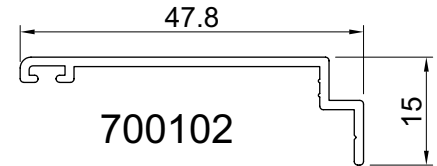
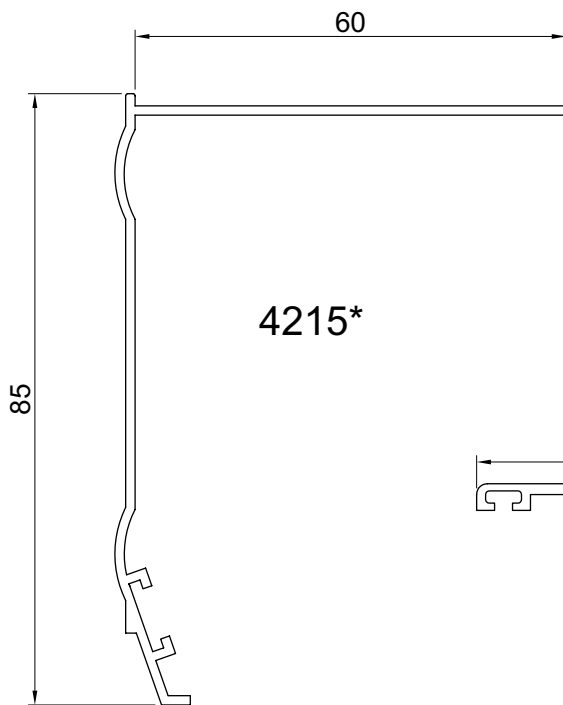
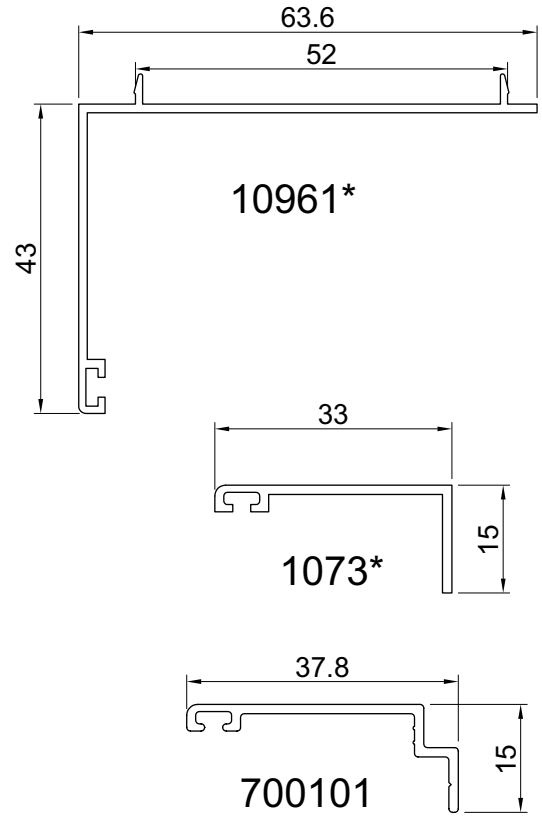
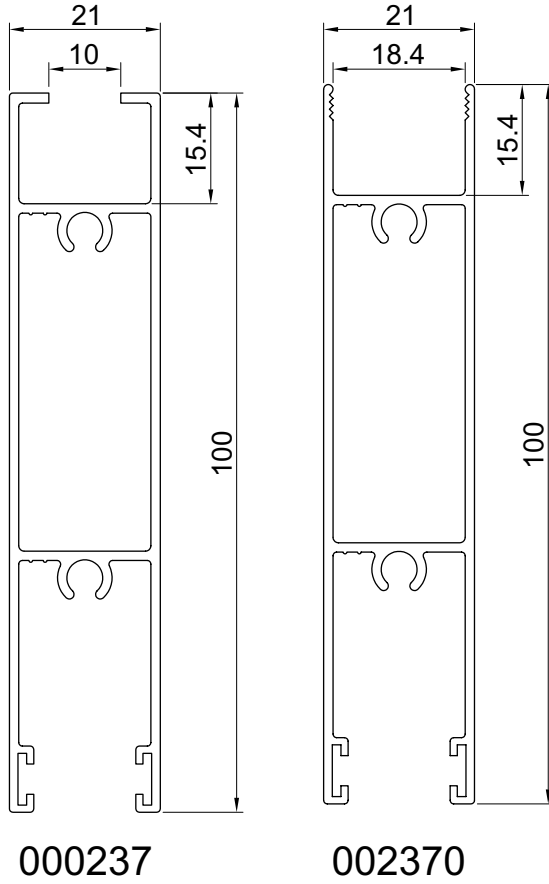

* SEGÚN NECESIDADES

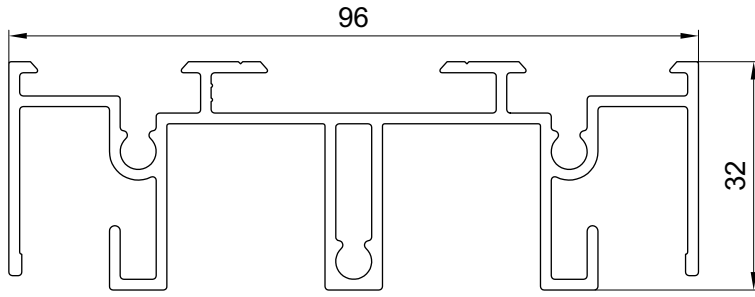

02313

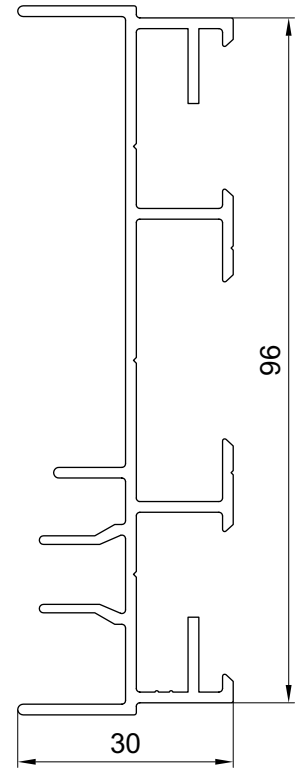

02333

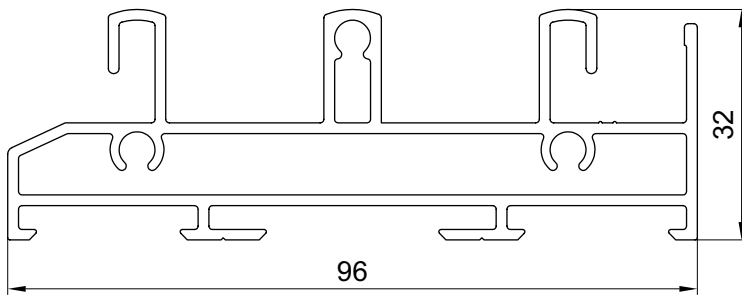

02323

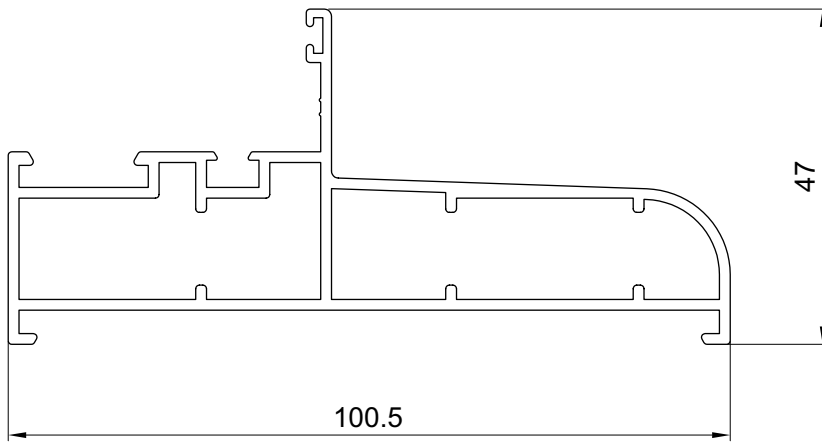

700083

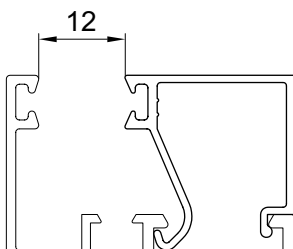

94301

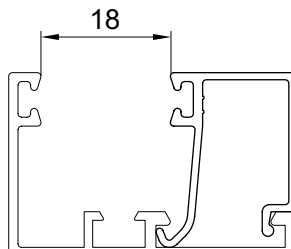

94302

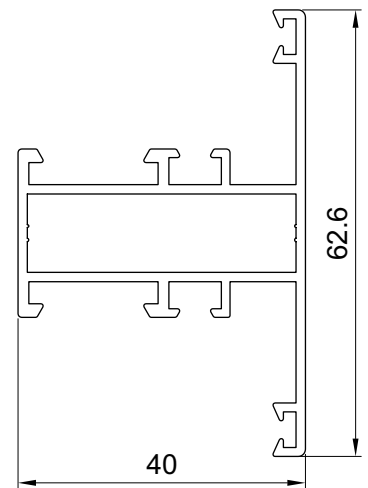

94103

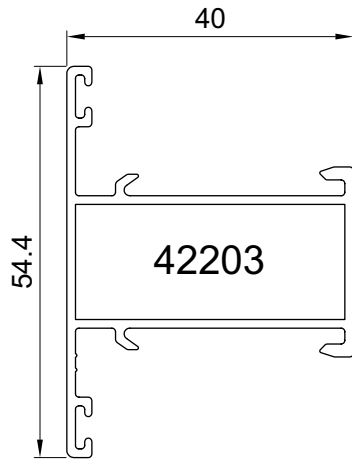

42203

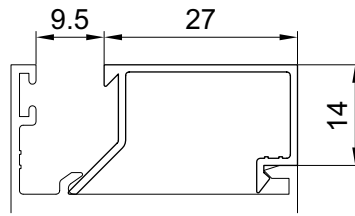

42010

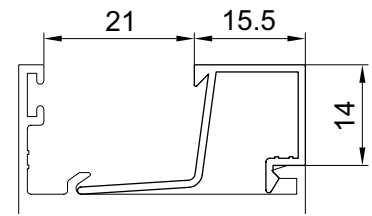

42008

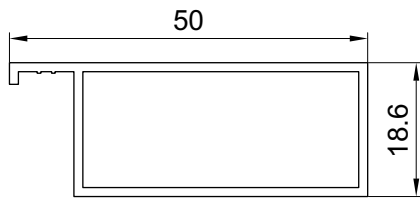

72014

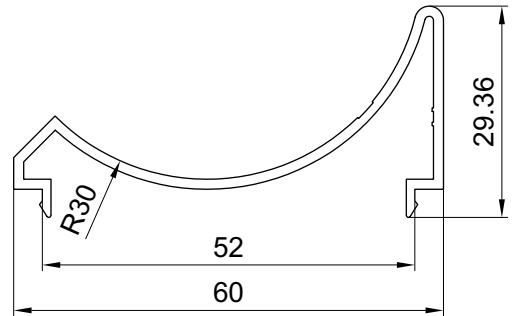

23035

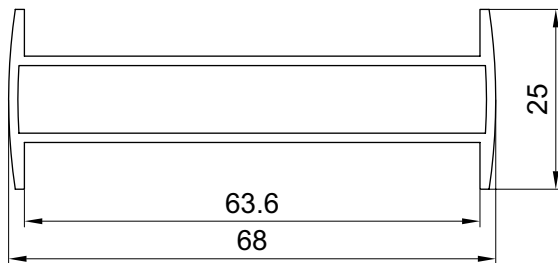

4656*

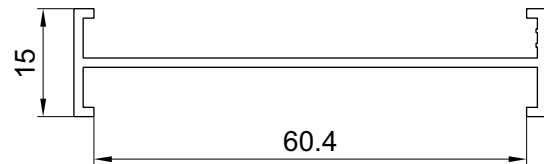

72012

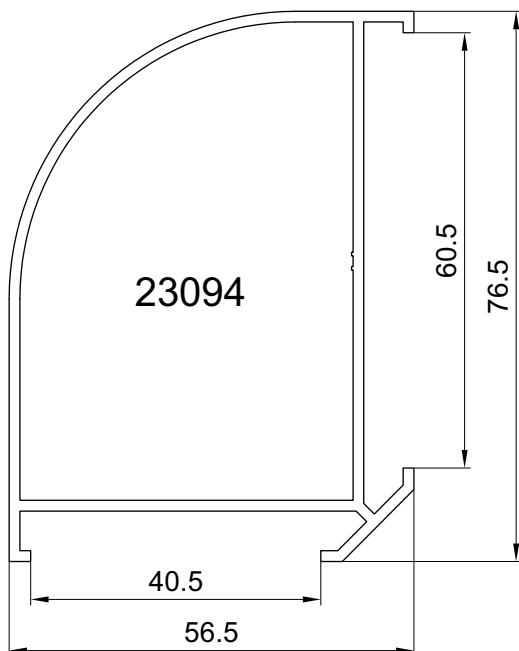

23094

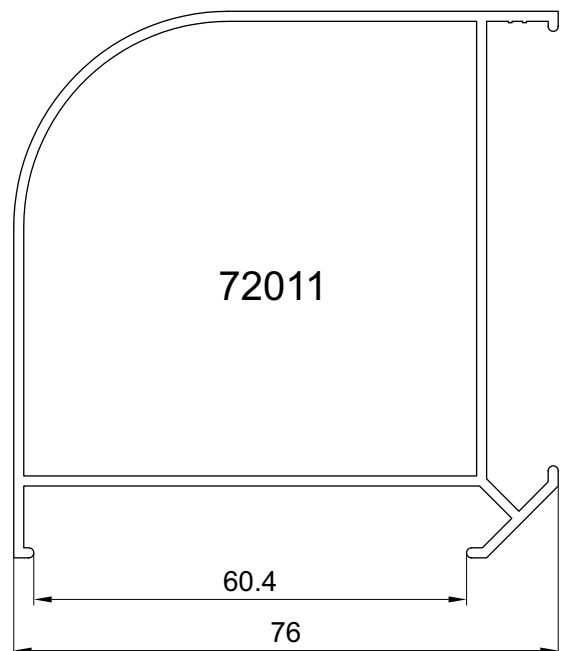

72011

* SEGÚN NECESIDADES

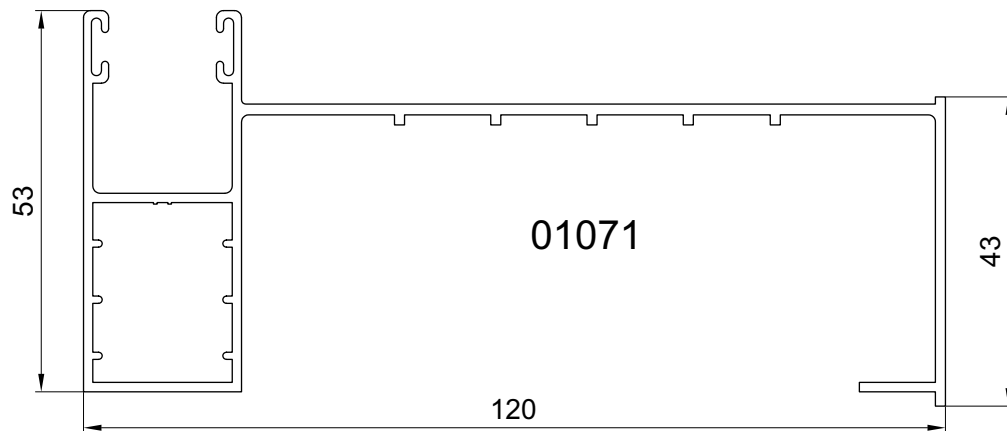
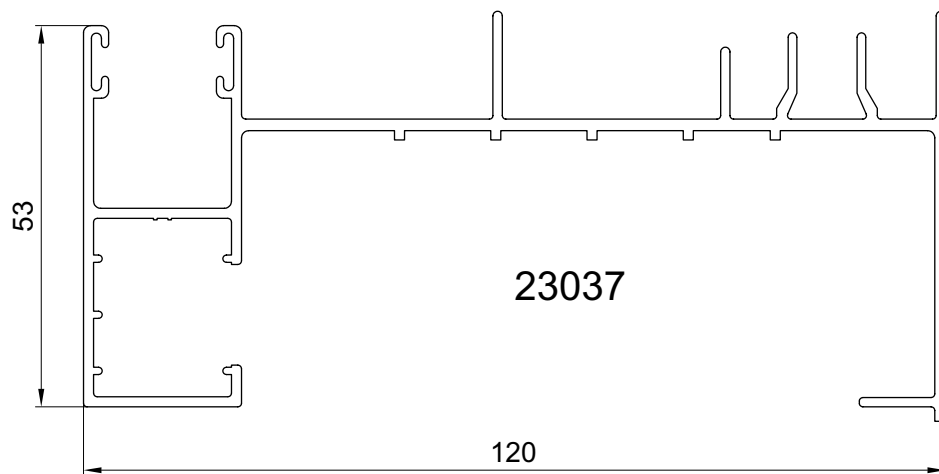
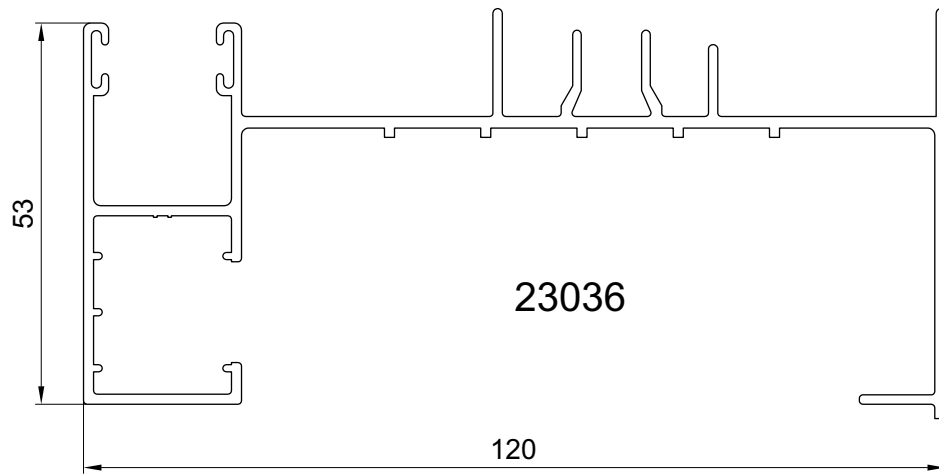

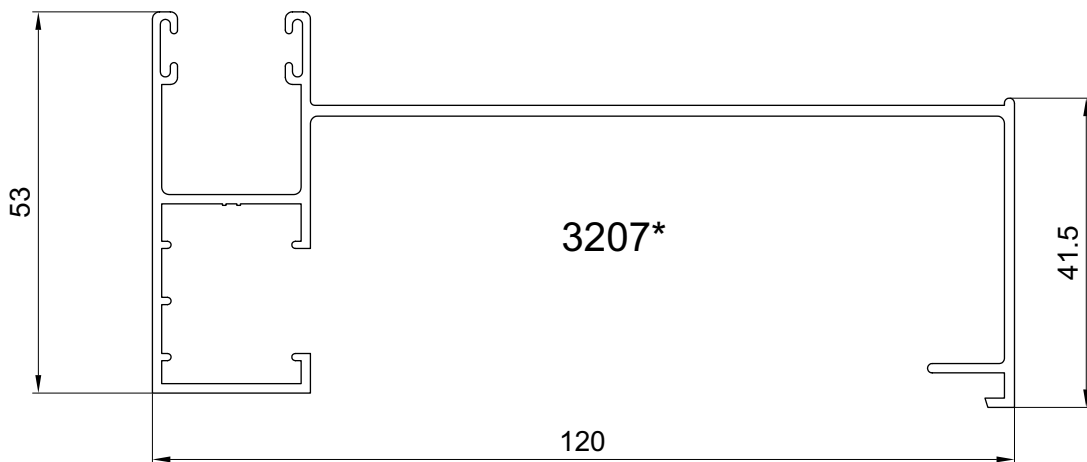
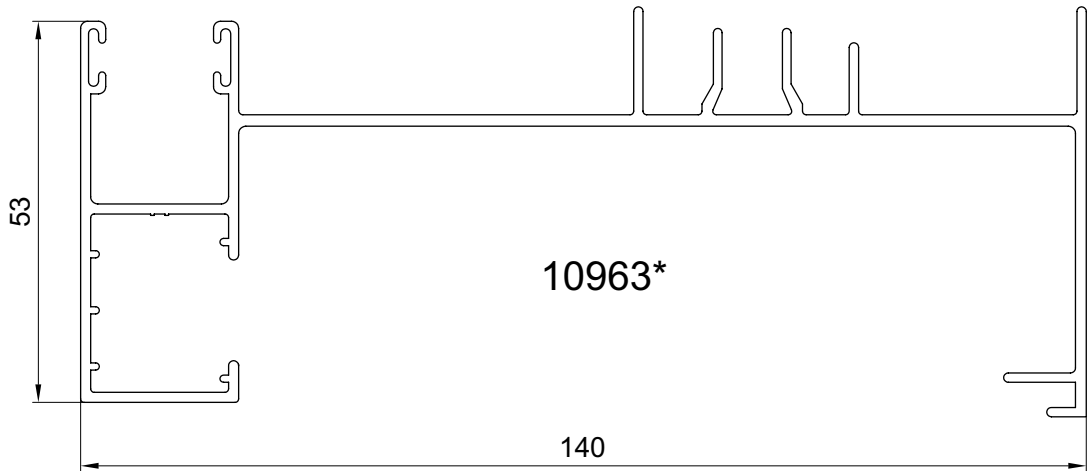
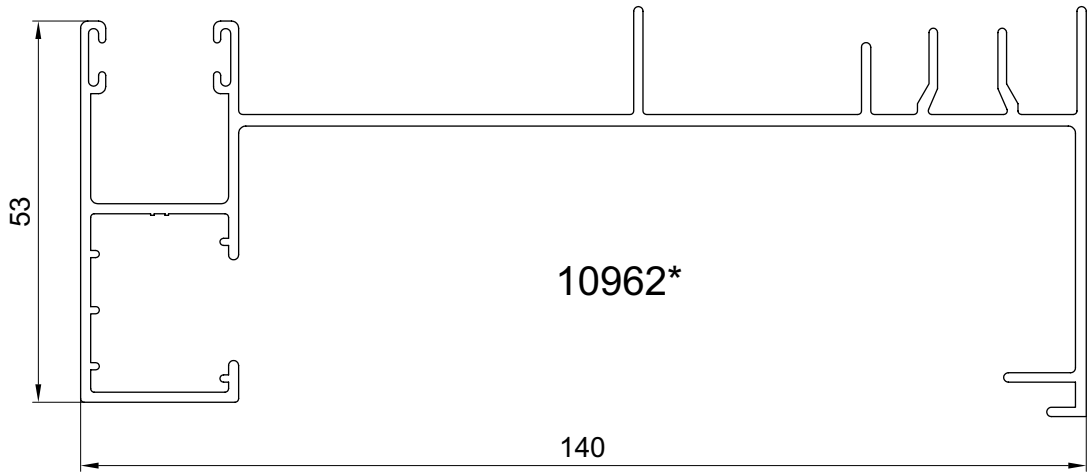

* SEGÚN NECESIDADES



01036

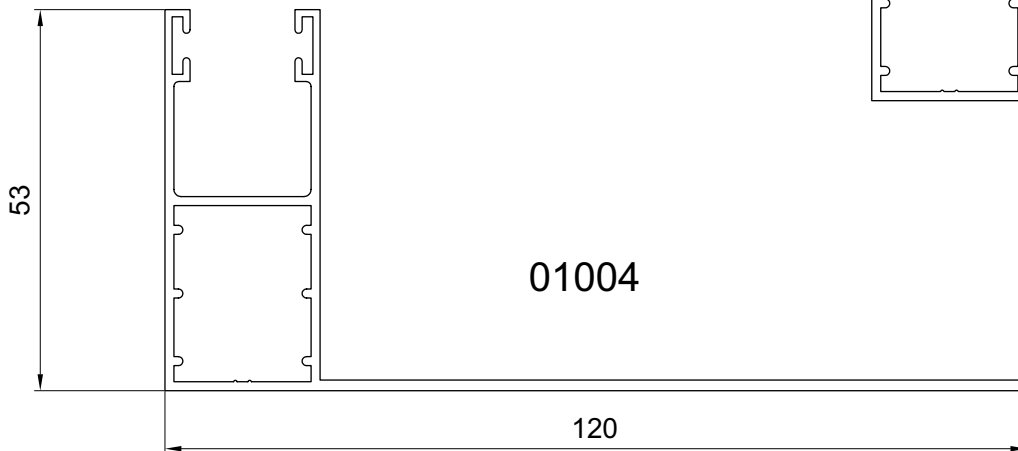
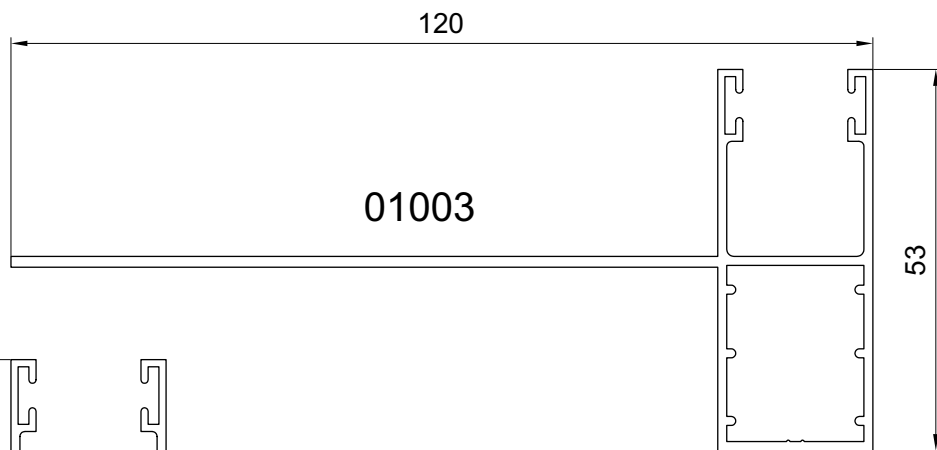
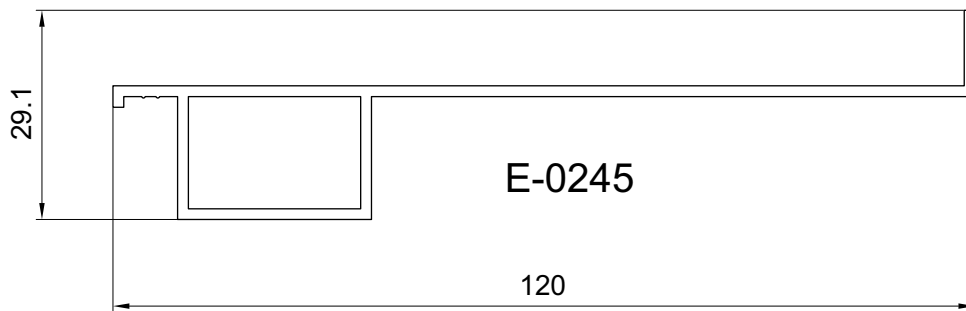
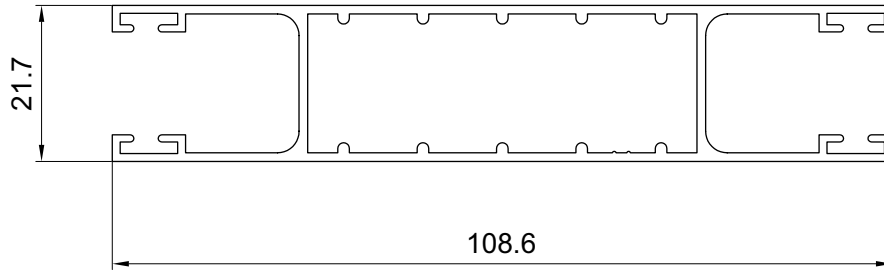

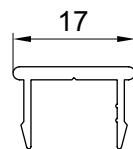
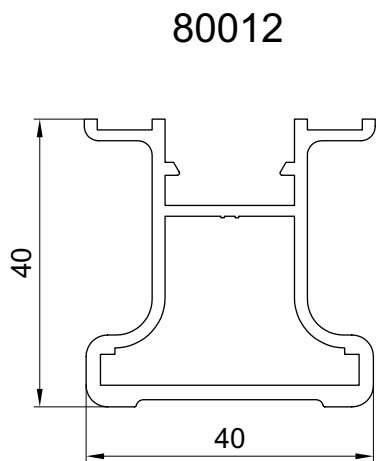
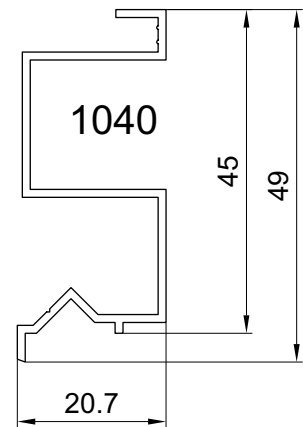
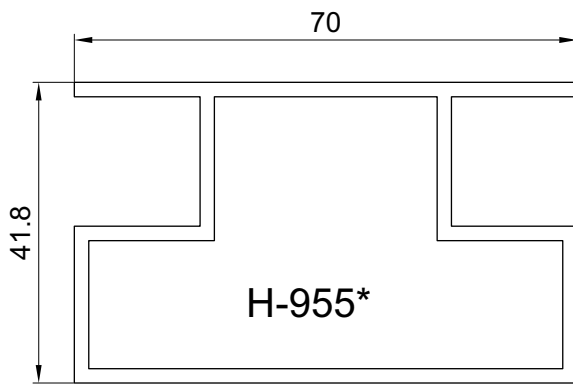
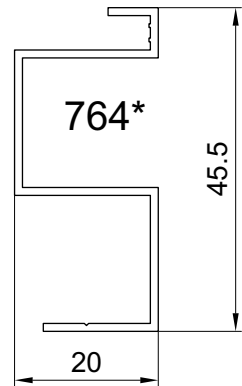
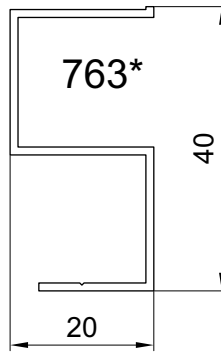
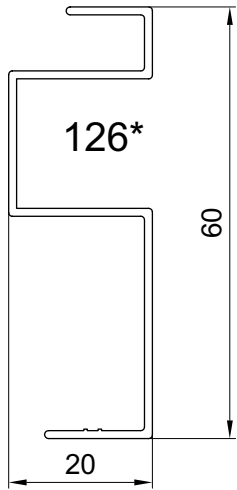

80013

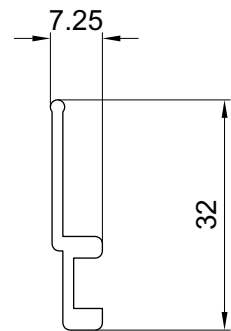

S/M-2300*

* SEGÚN NECESIDADES

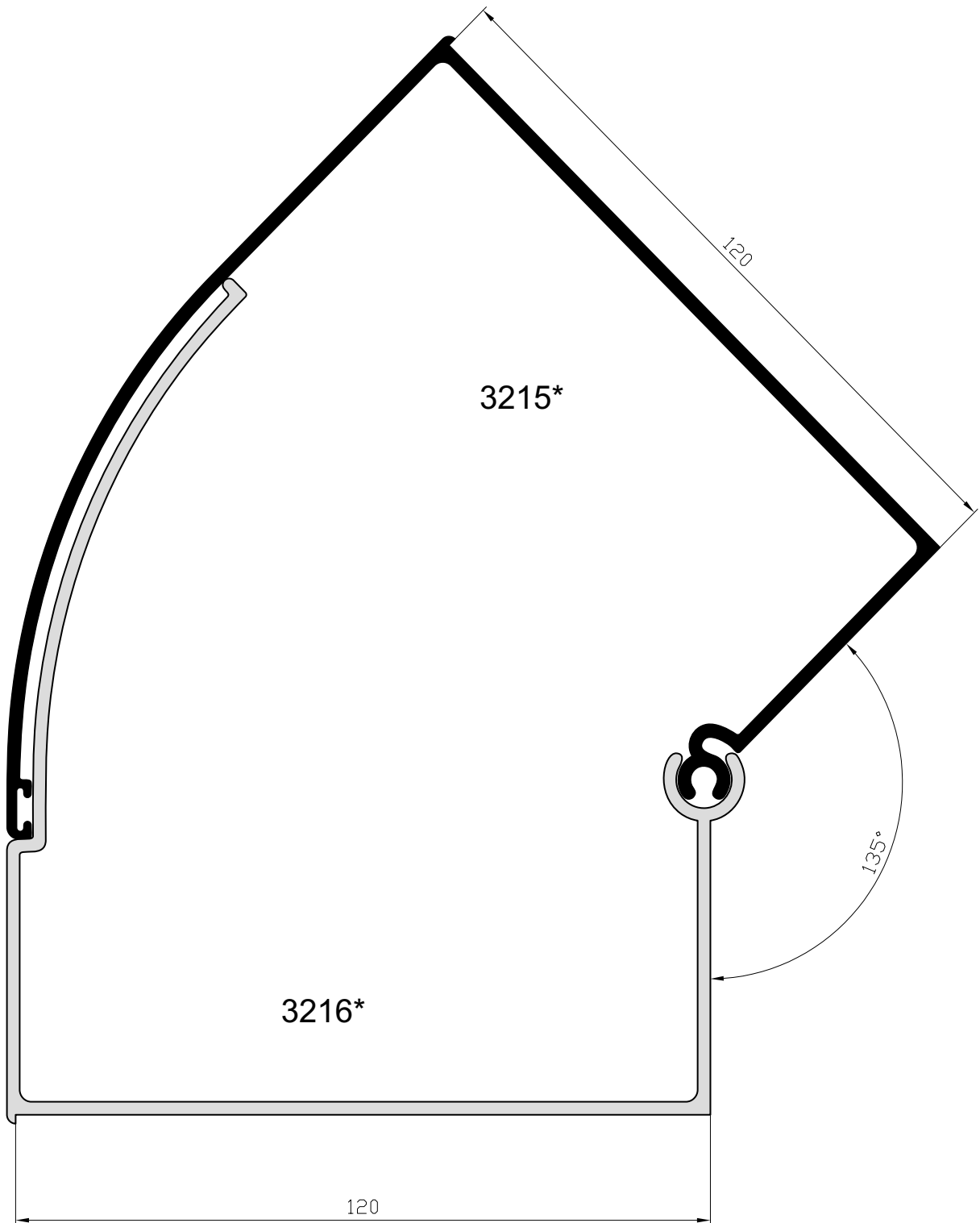

* SEGÚN NECESIDADES

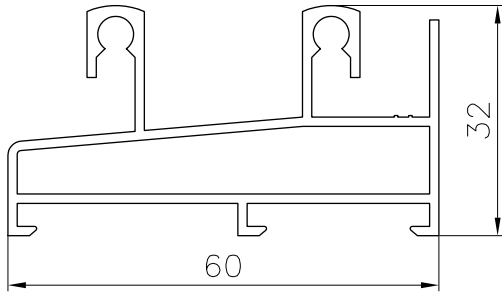

23001

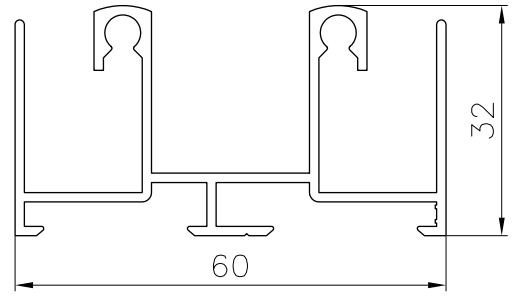

23002

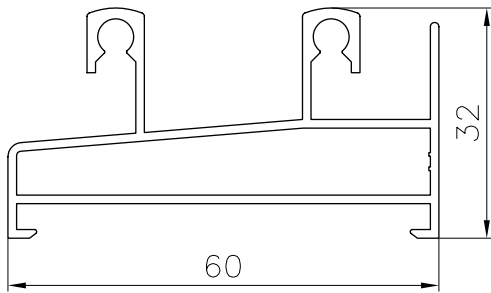

23102

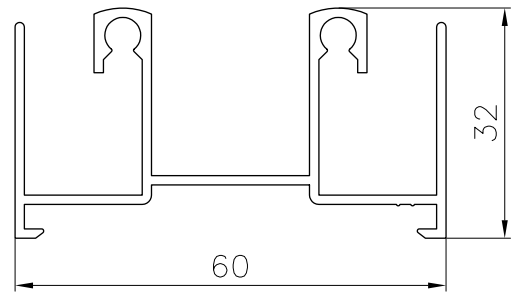

23101

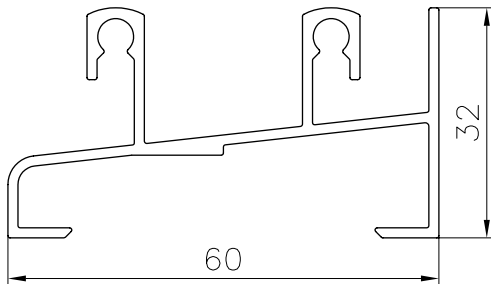

23121

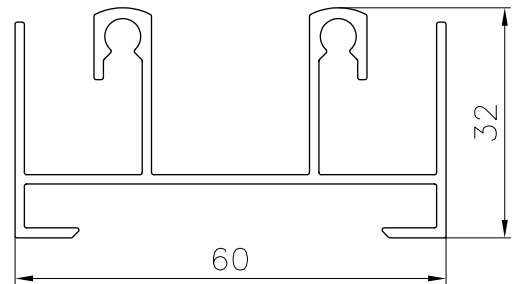

23124

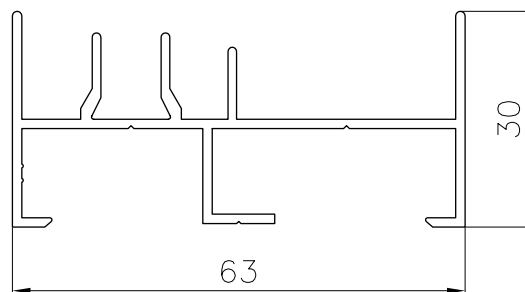

23015

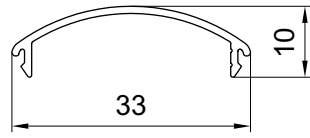

002331

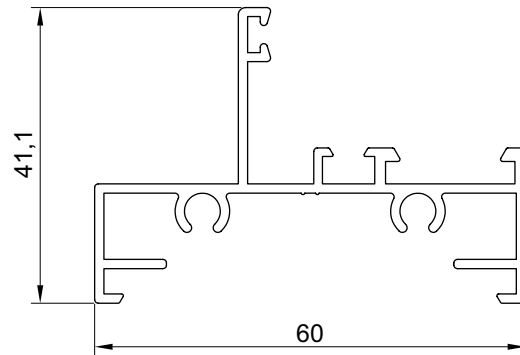

000238

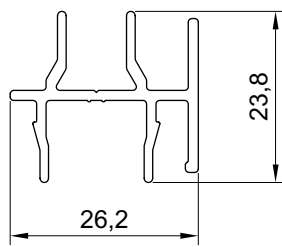

700141

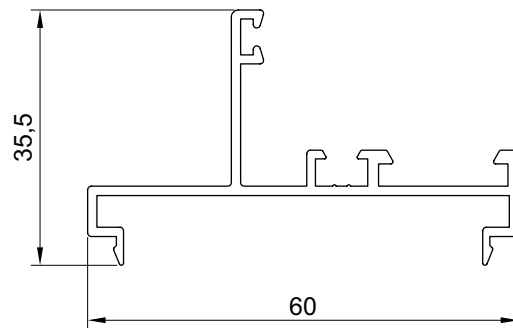

000239

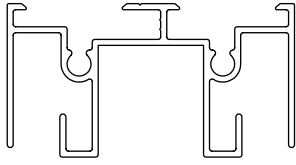

000231

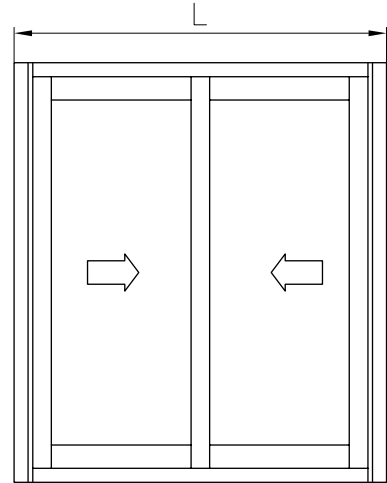
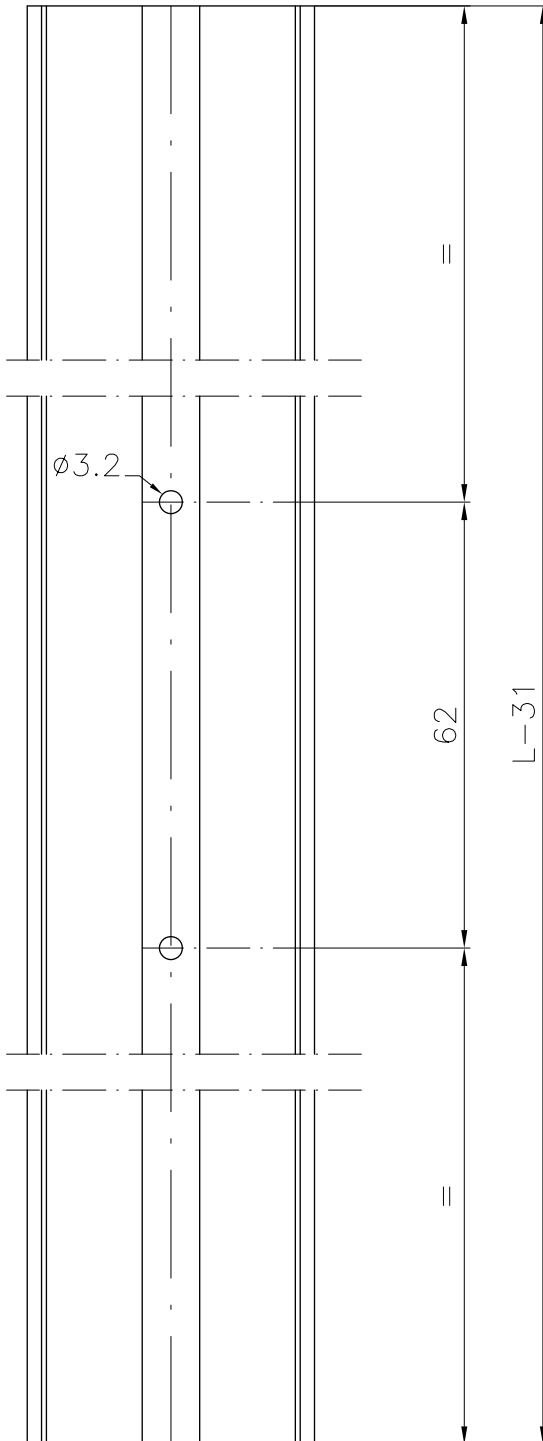

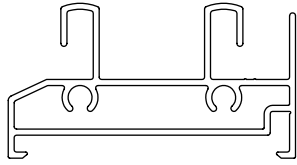

000232

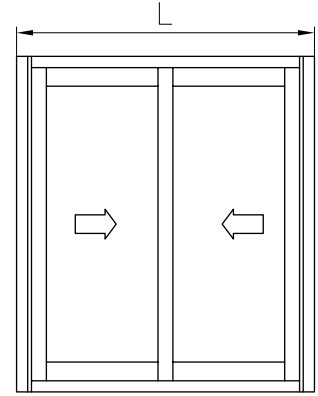
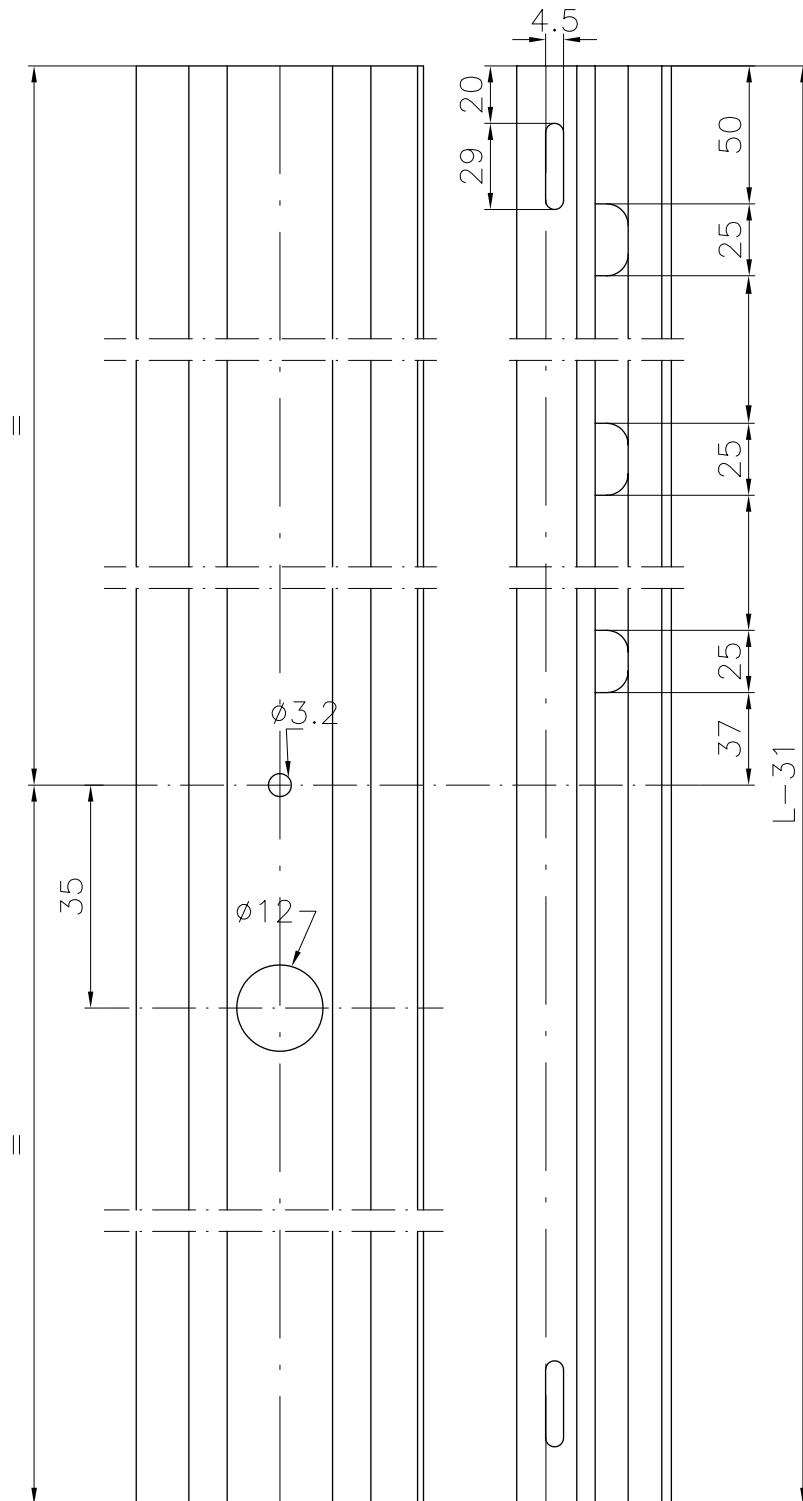

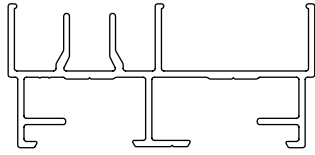

002330

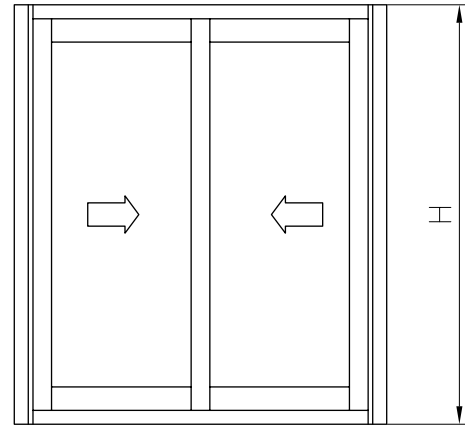
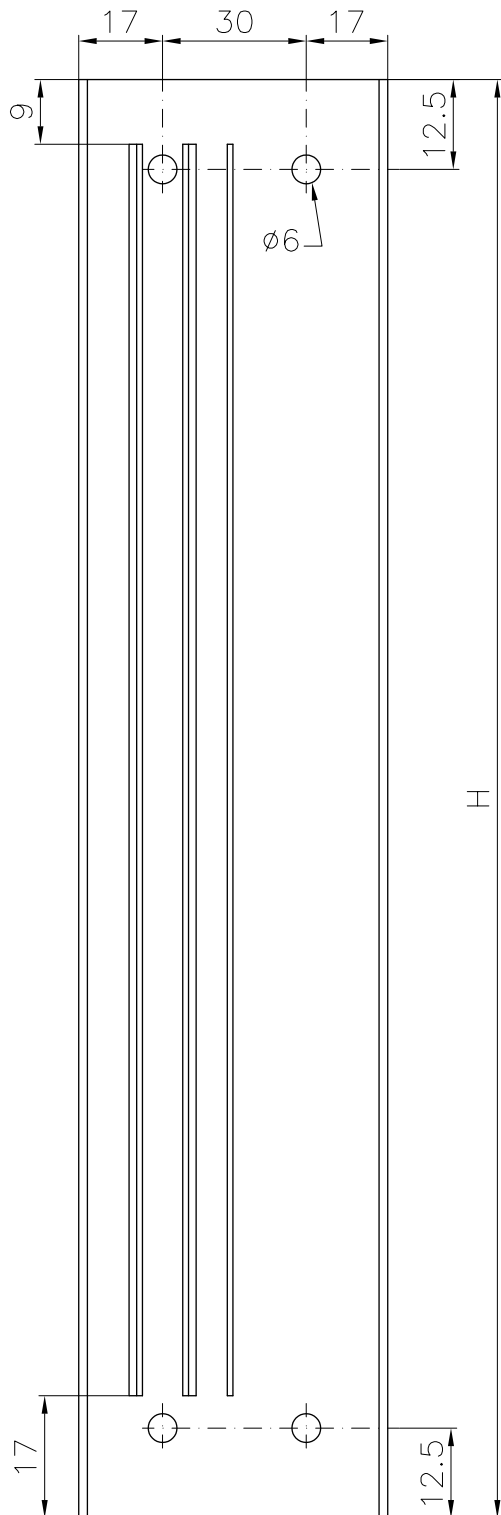

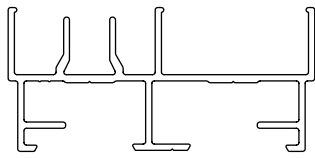

002330

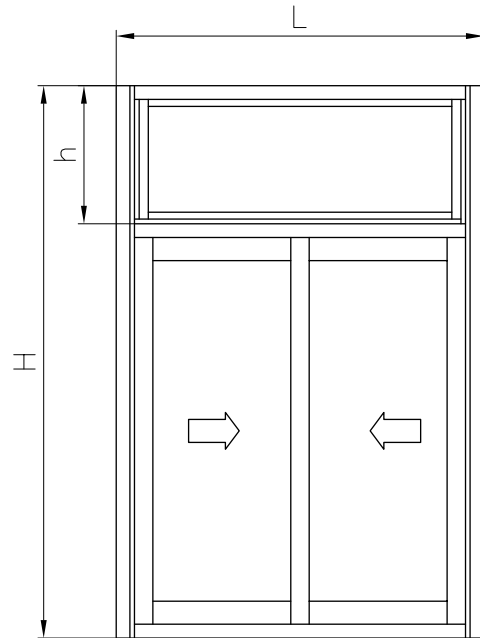
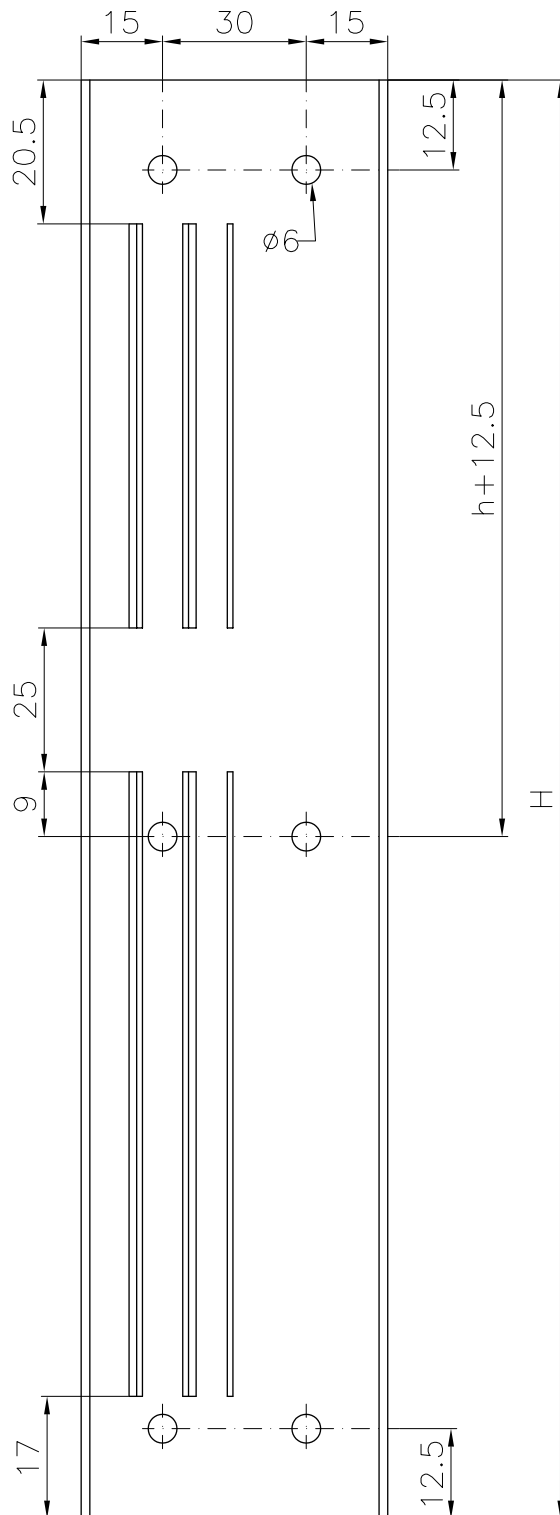

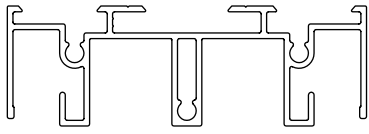

002313

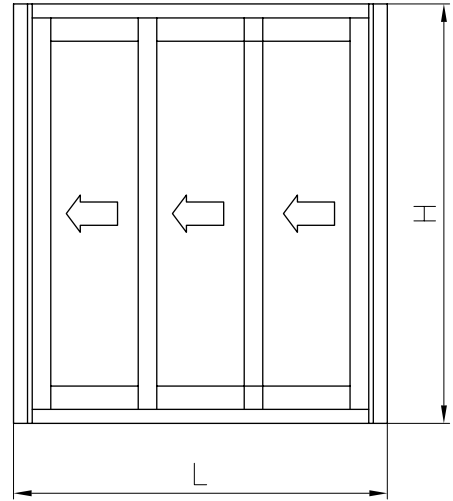
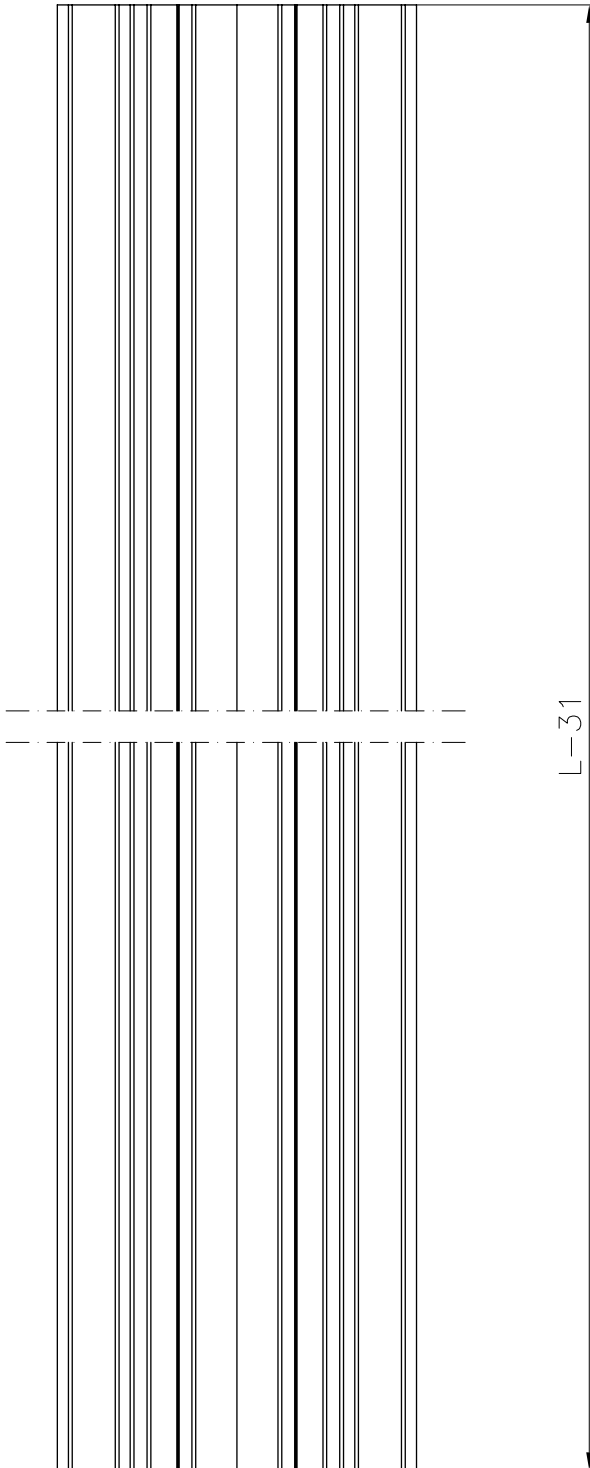

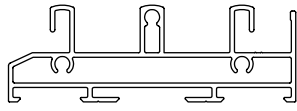

002323

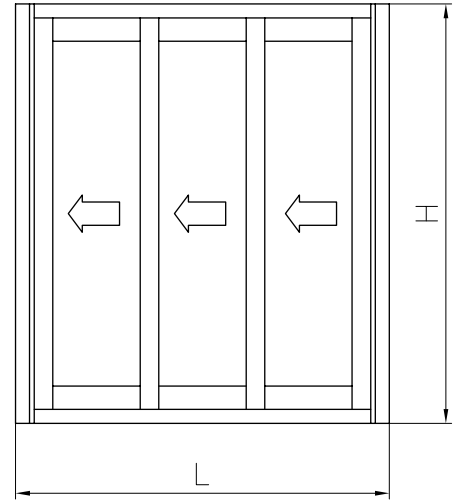
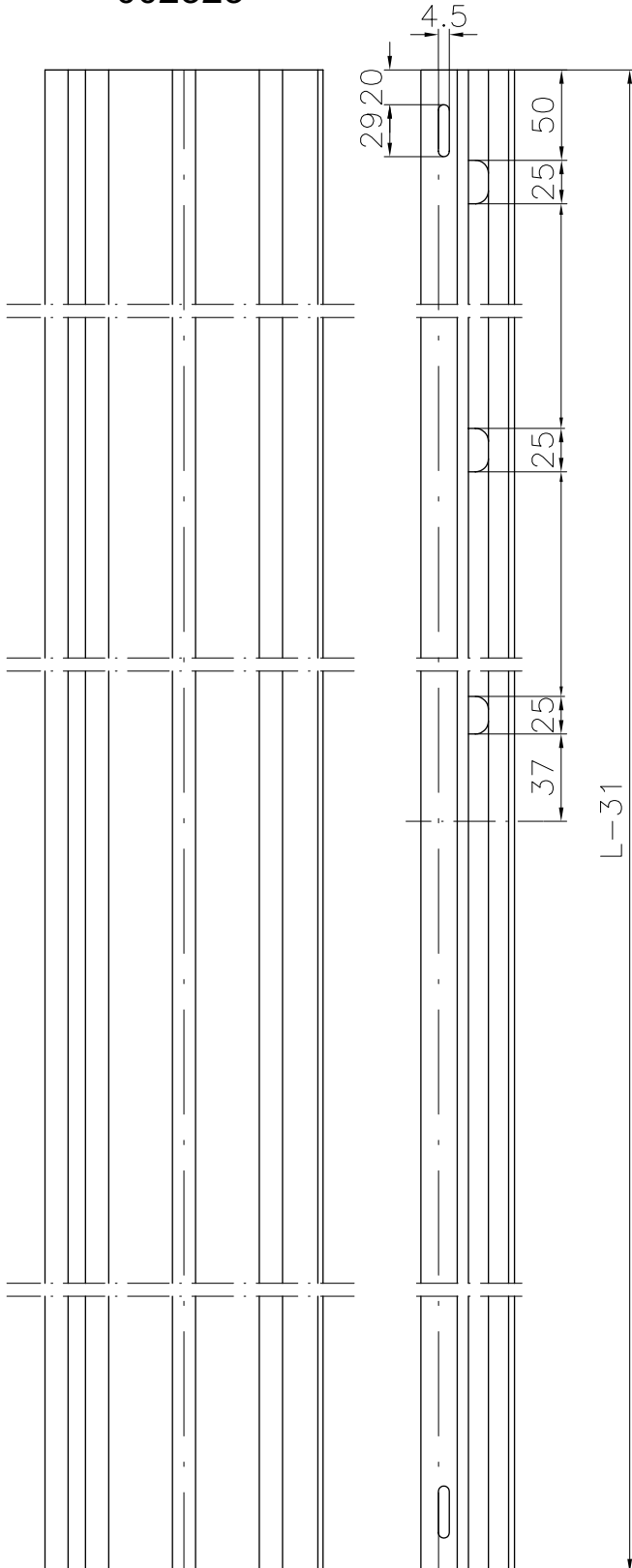

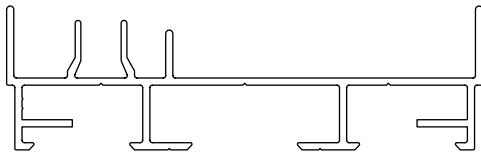

02333

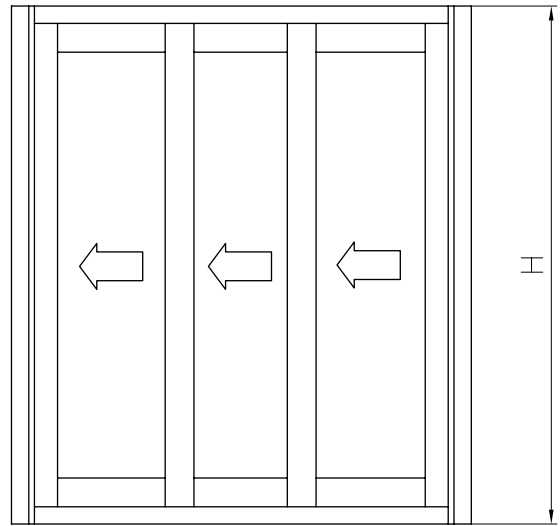
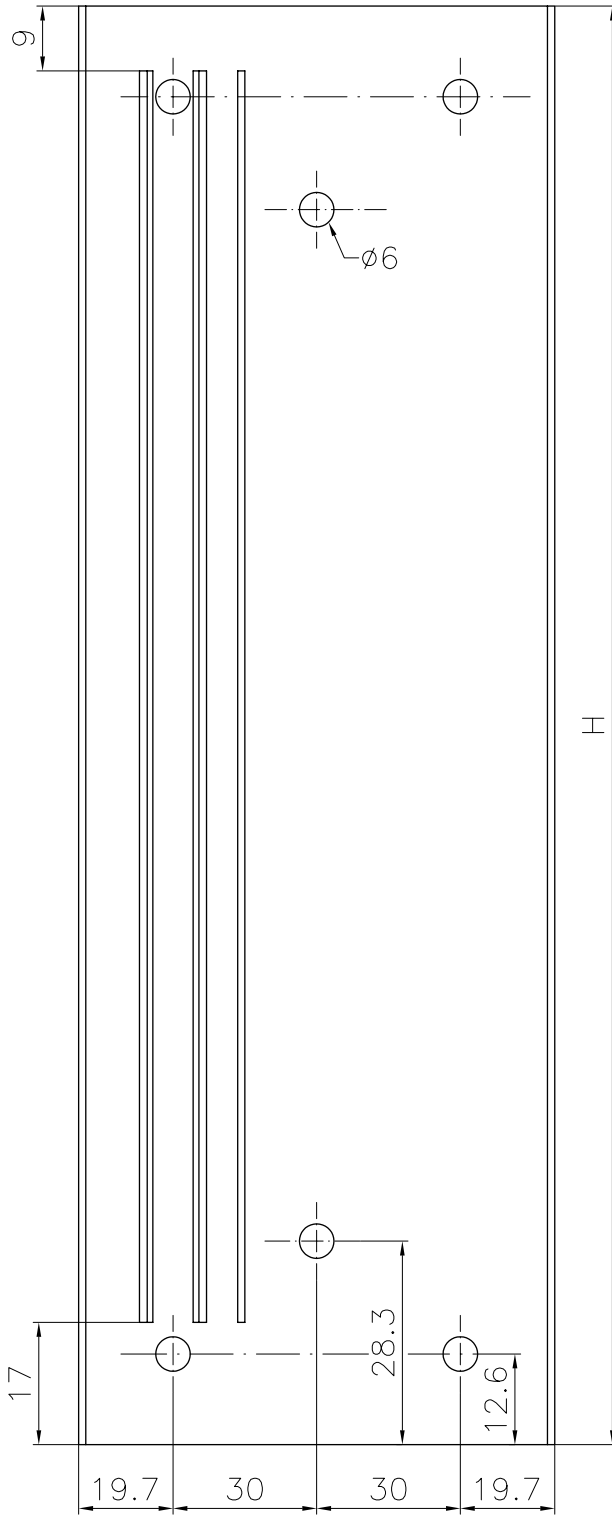

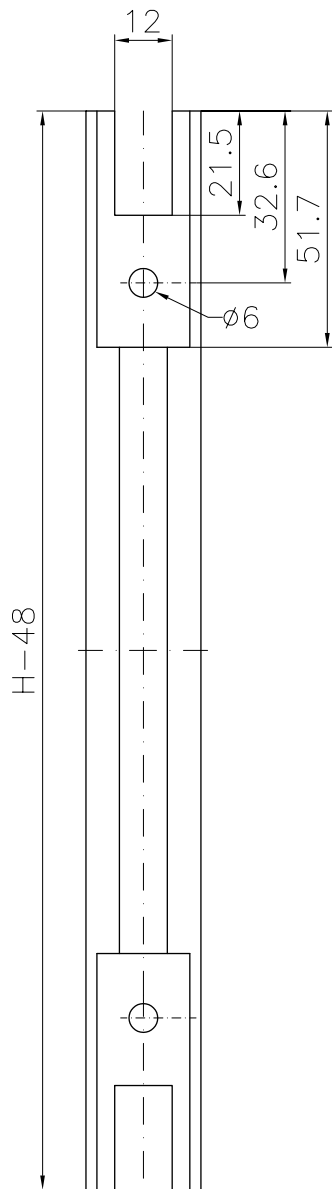

000234

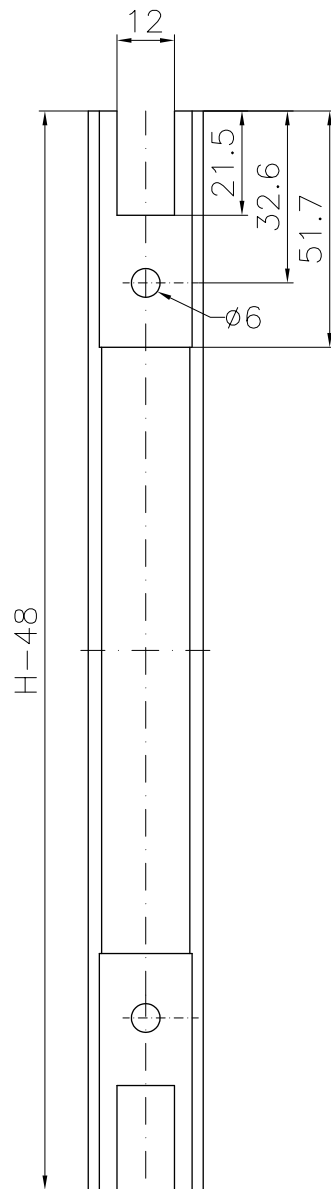

002340

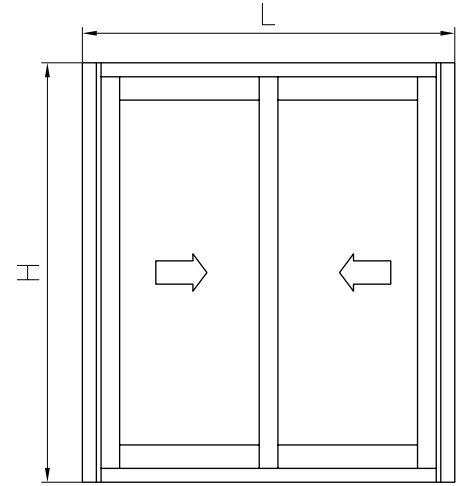

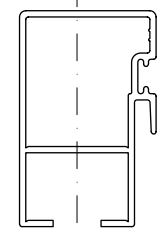
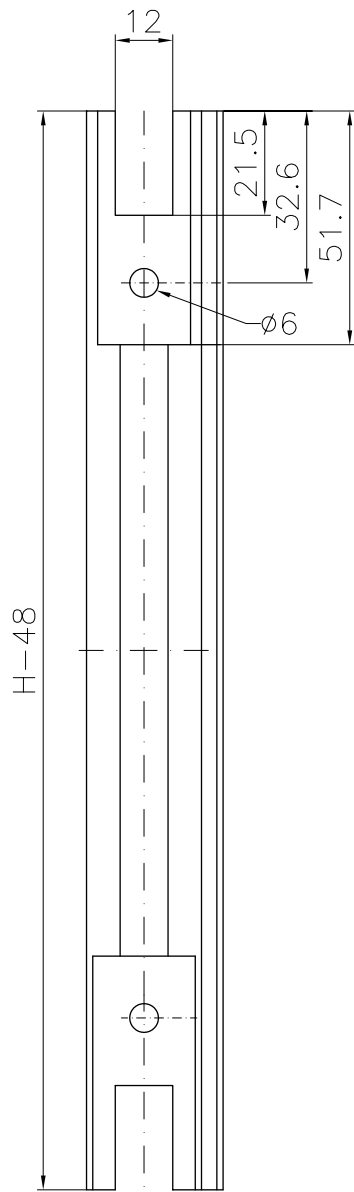

000235

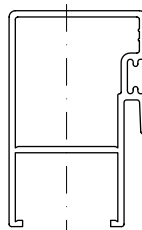
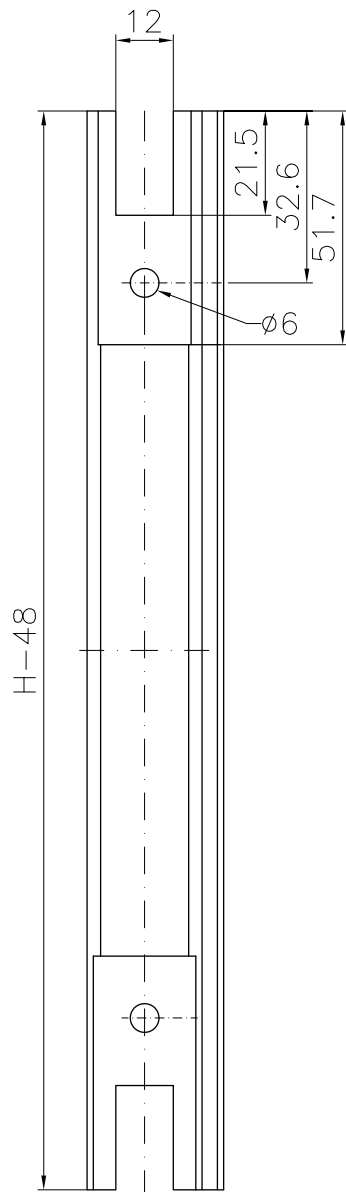

002350

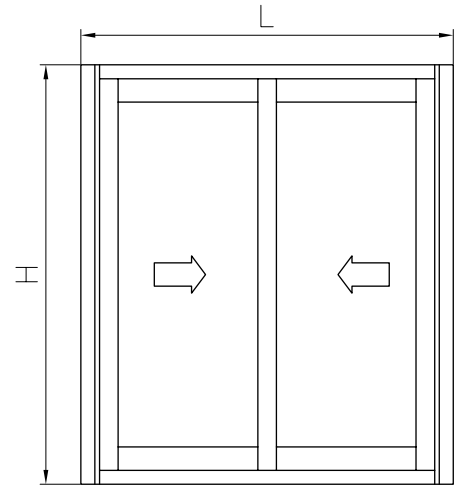

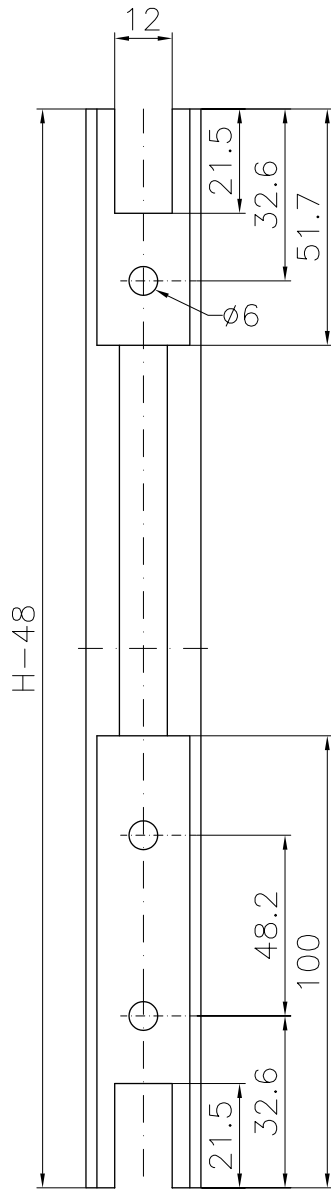

000234

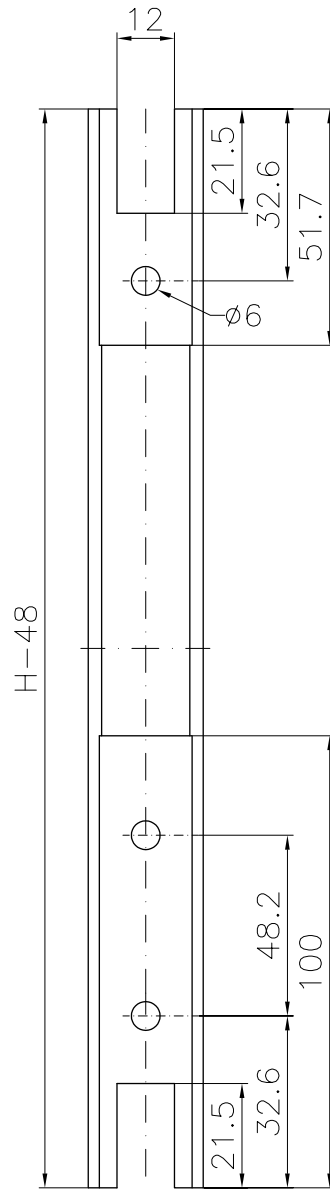

002340

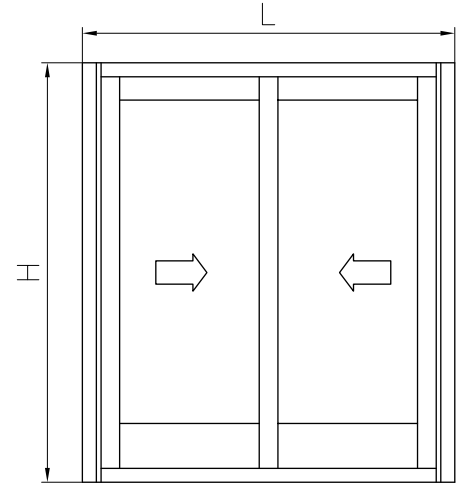

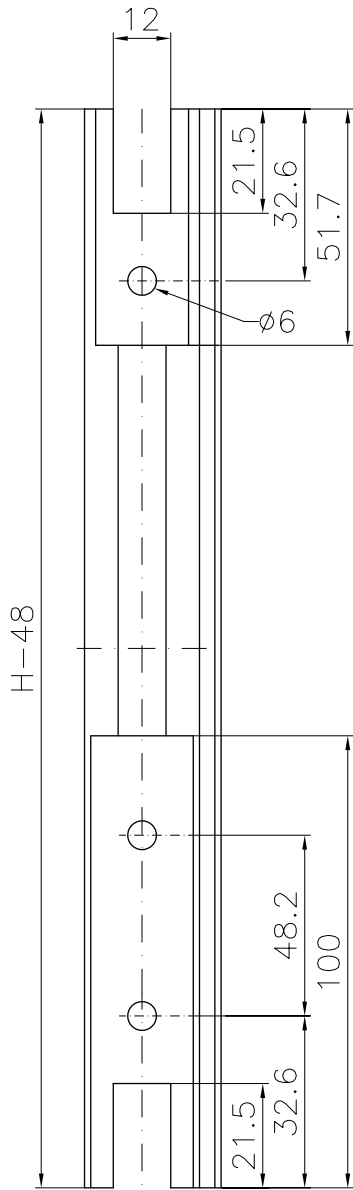

000235

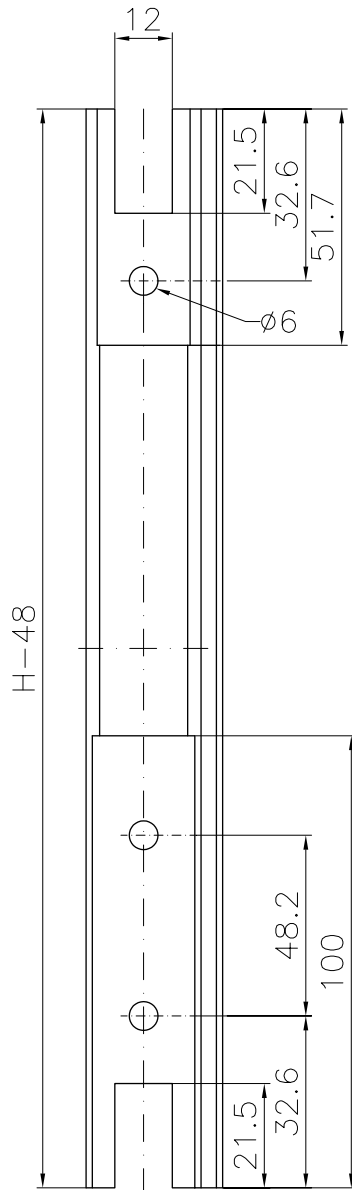

002350

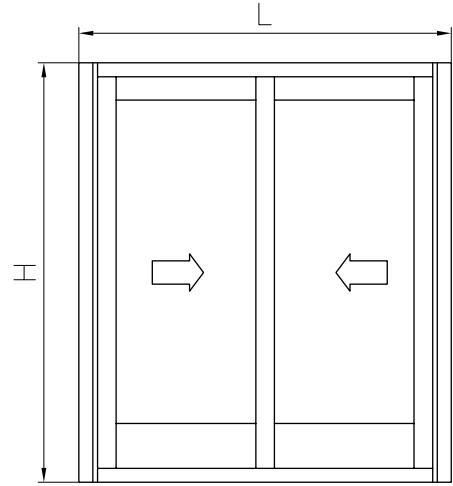

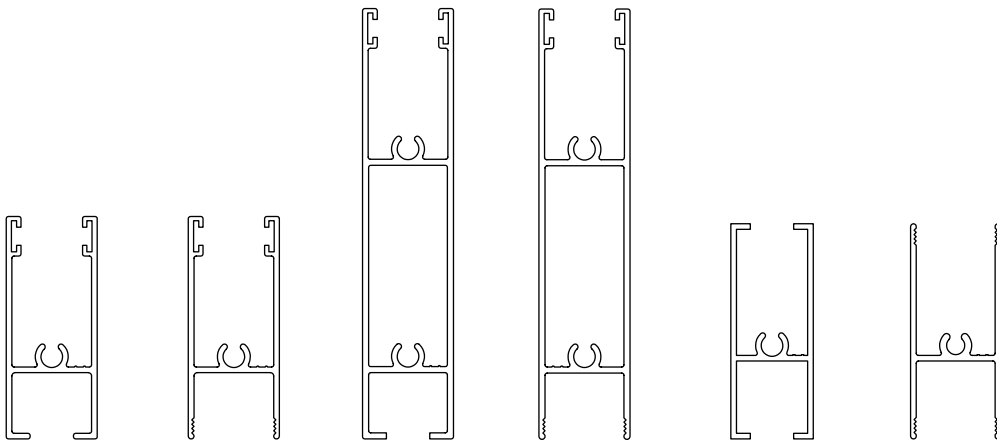
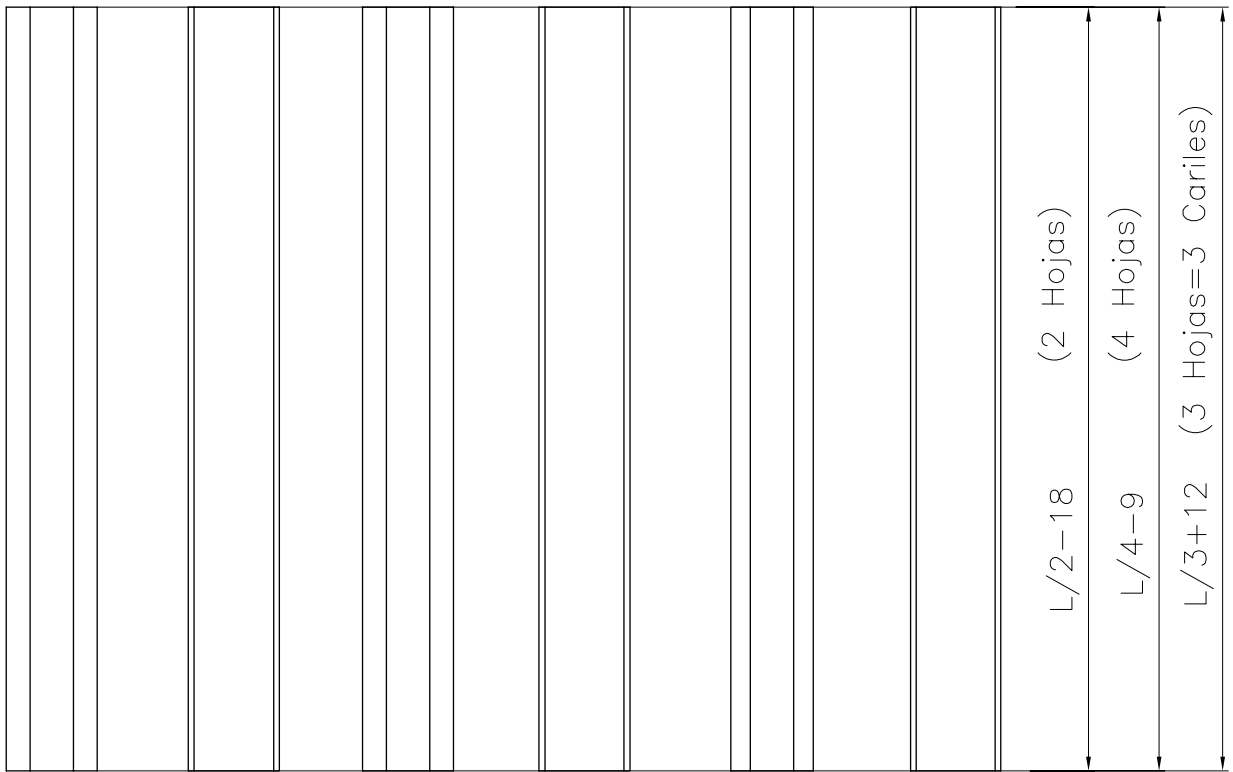
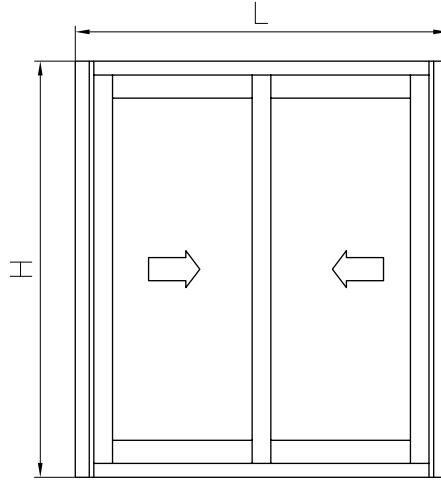

000236

002360

000237

002370

23061

700062

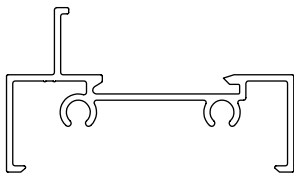

23010

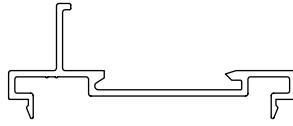

23011

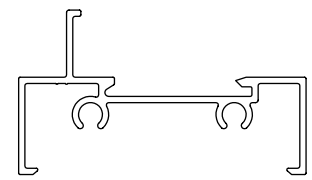
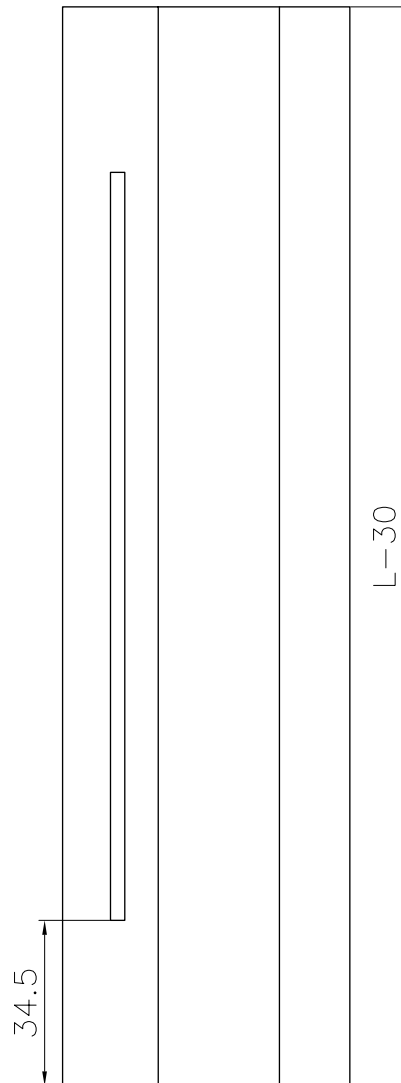
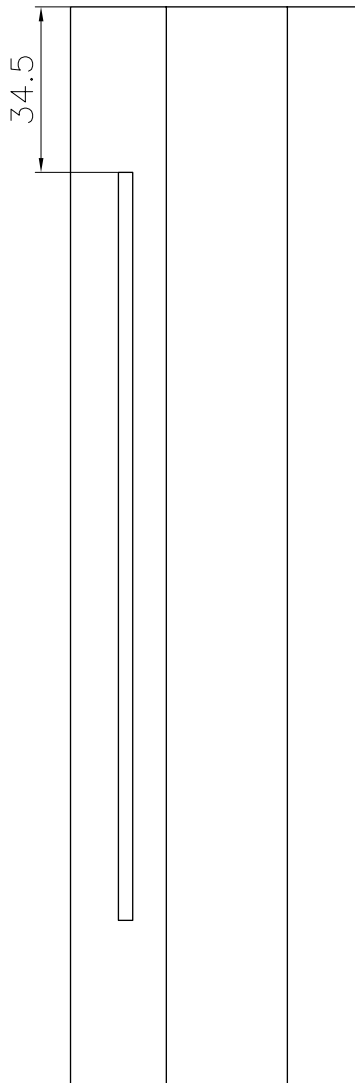
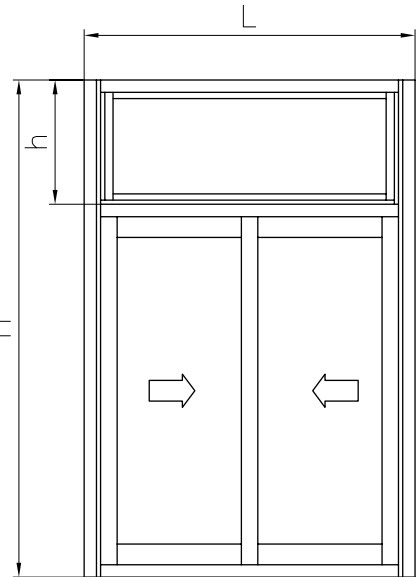

23010

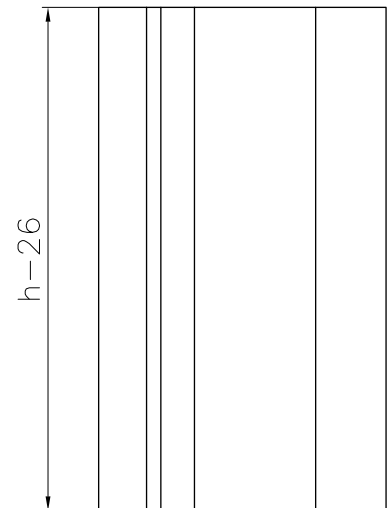

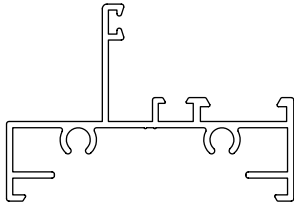

000238

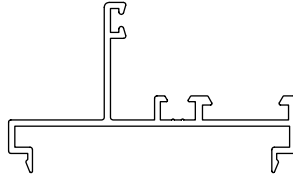

000239

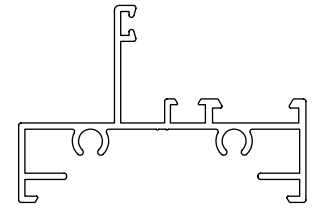
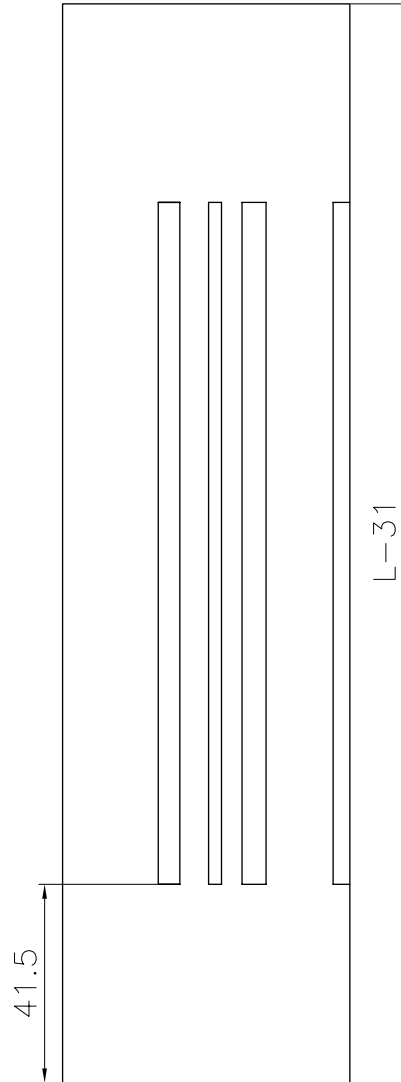
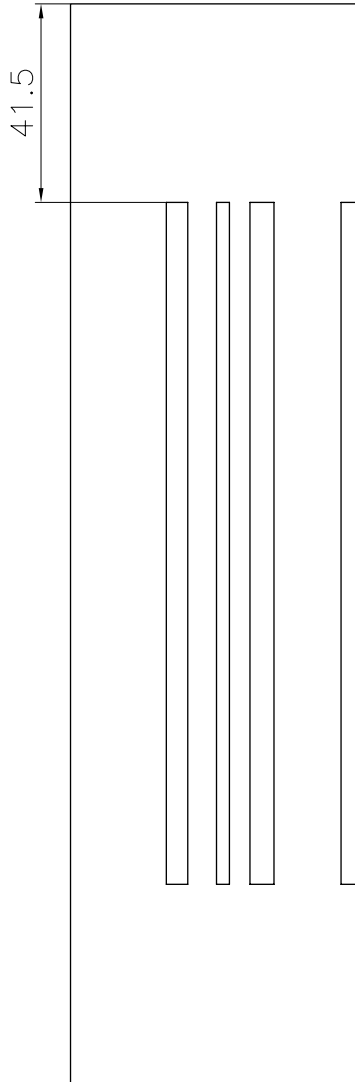
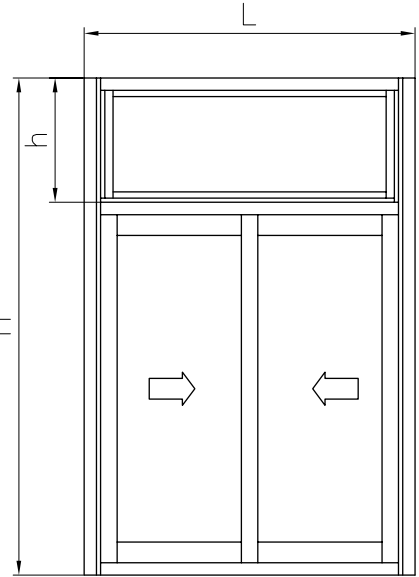

000238

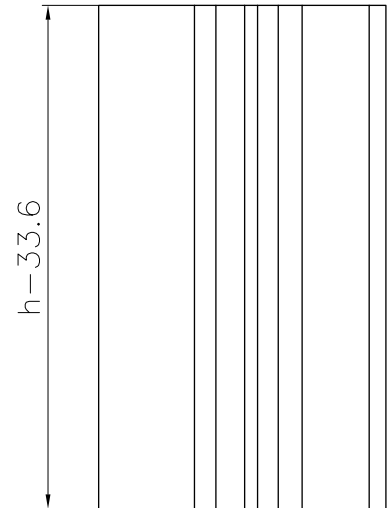



Sección B-B'

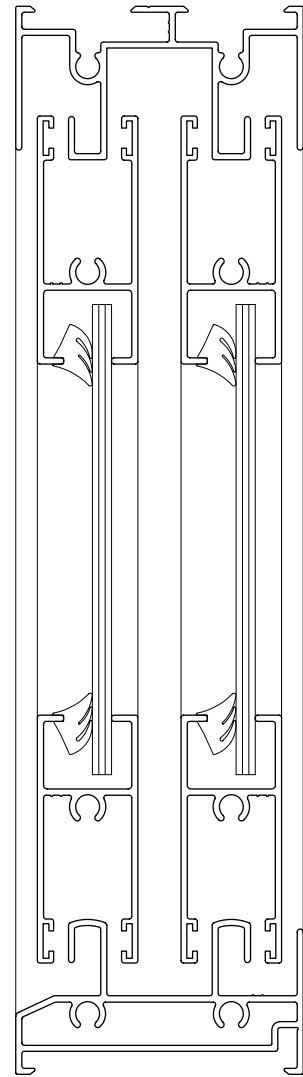
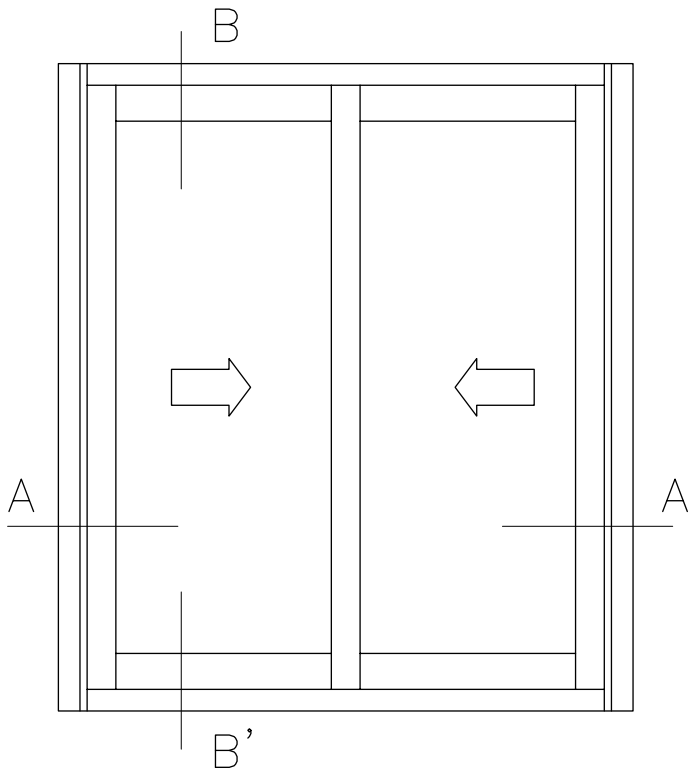

Sección A-A'

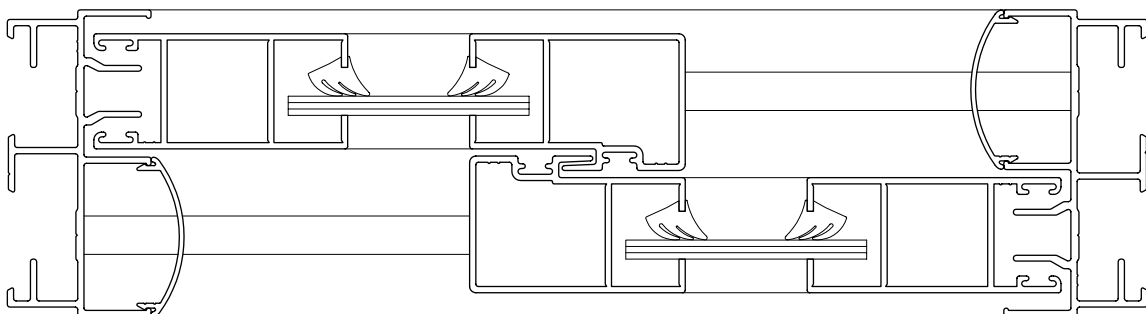

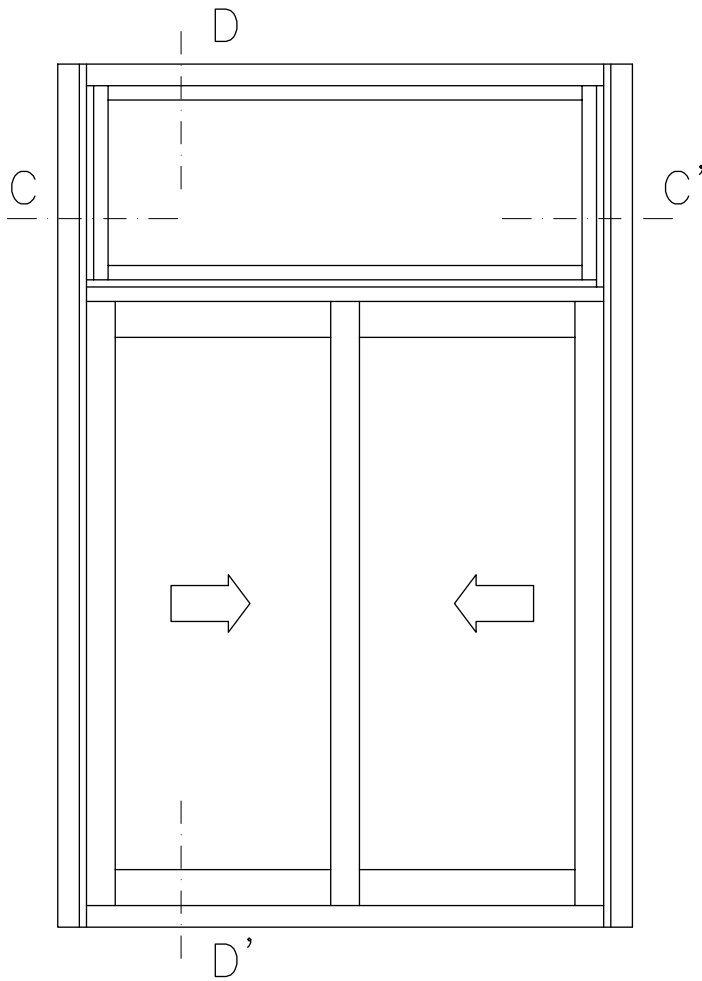

FIJOS SERE 6000

Sección D-D'

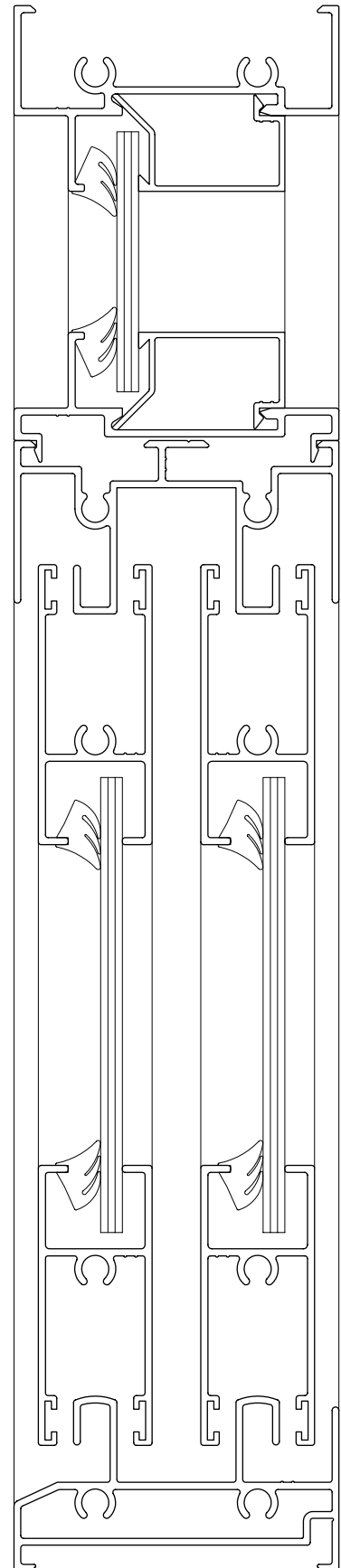

Sección C-C'

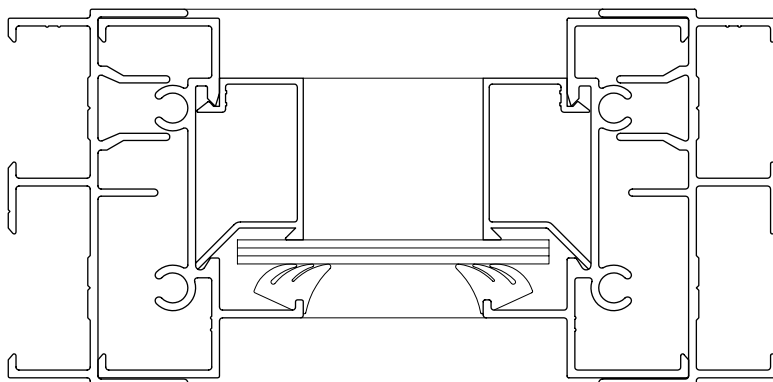

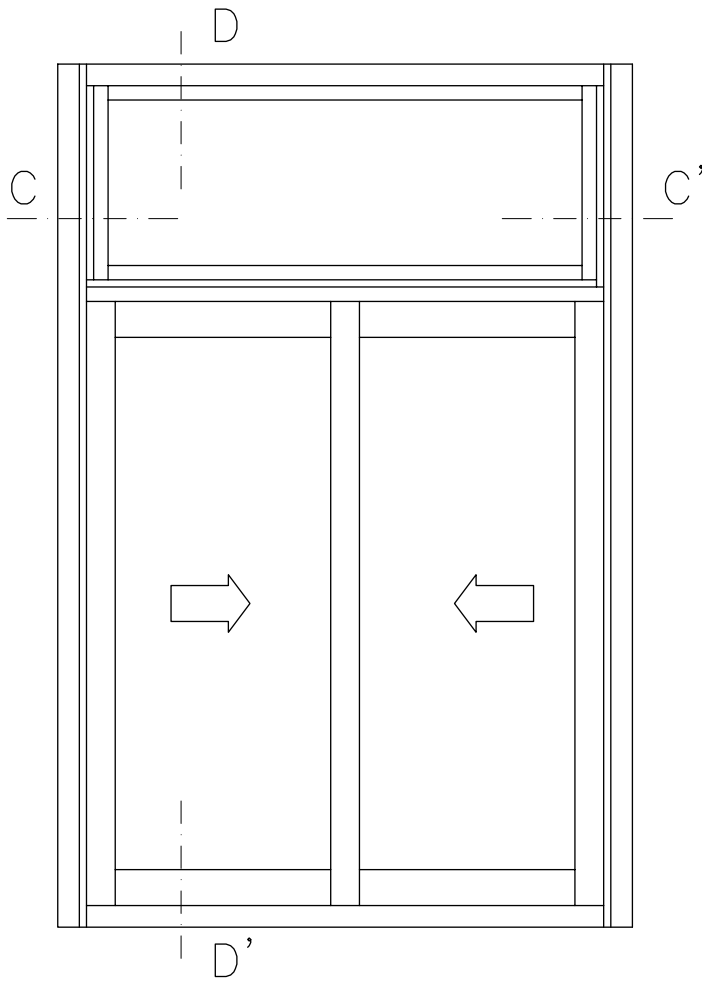

FIJOS CAMARA EUROPEA

Sección C-C'

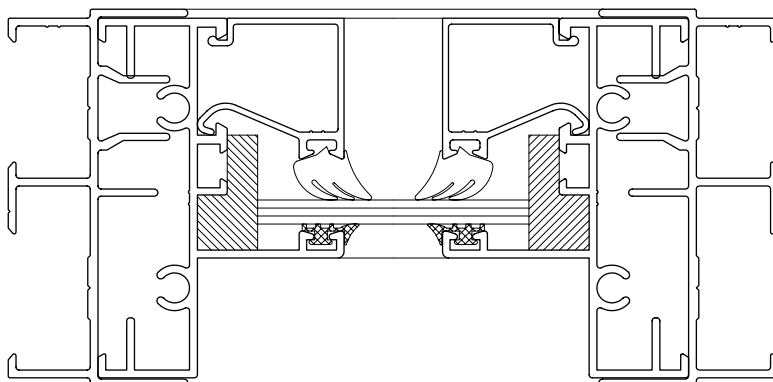

Sección D-D'

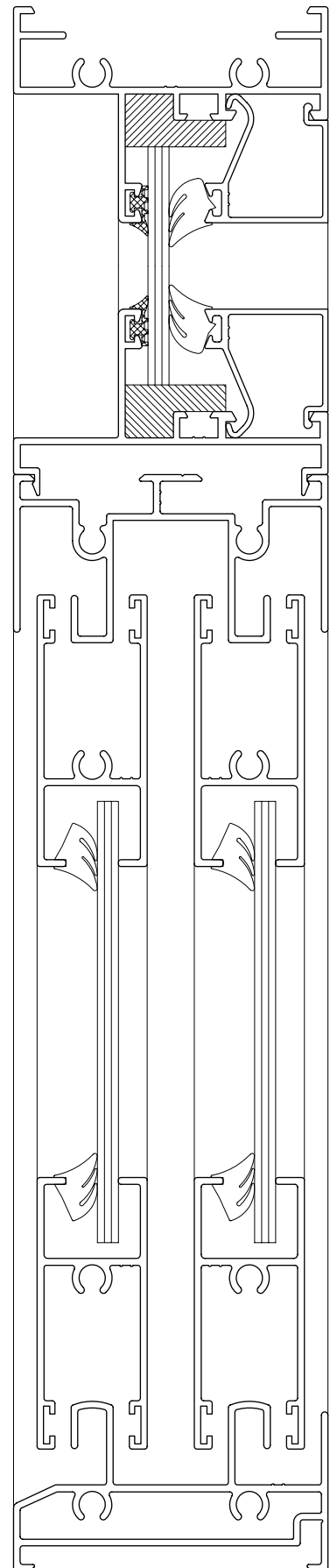



Sección D-D

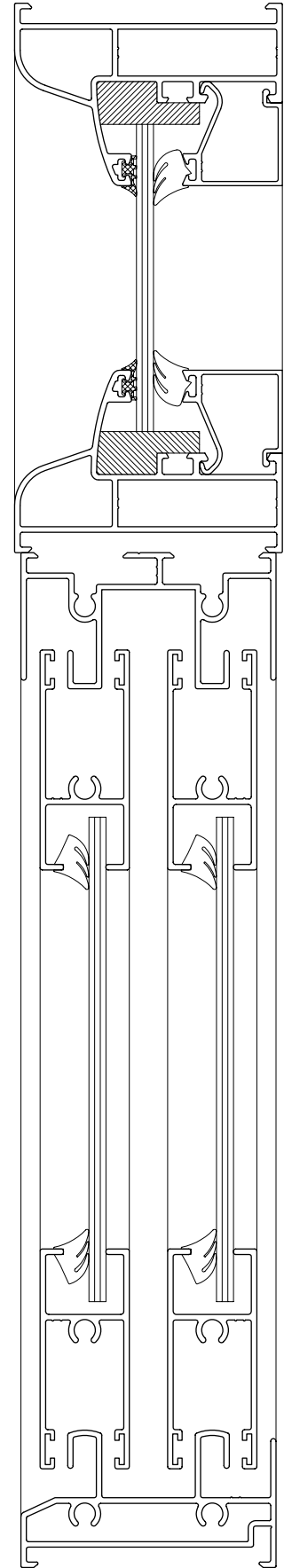
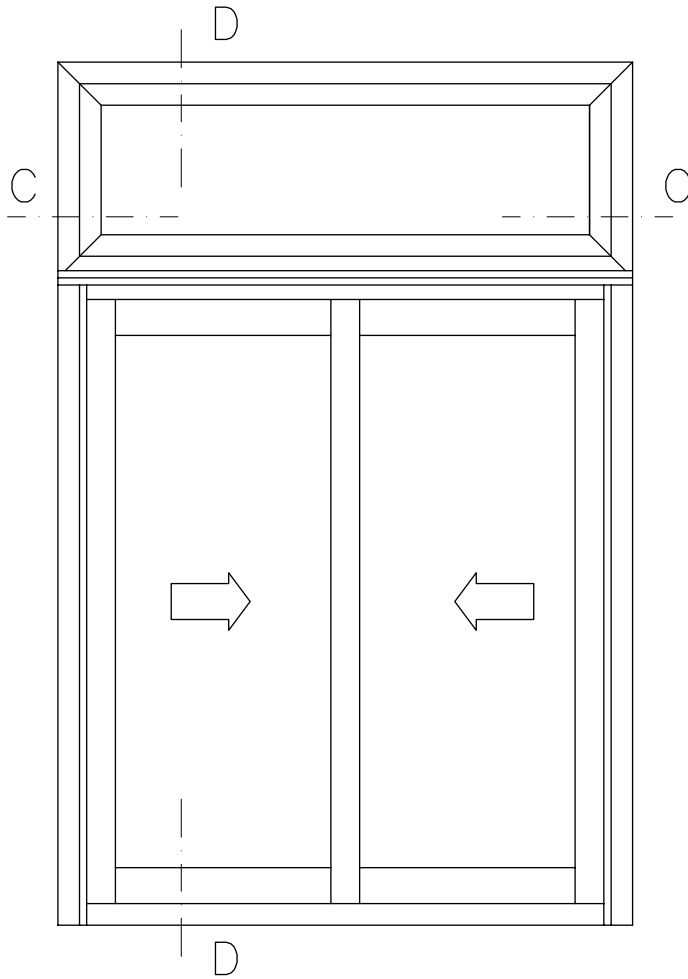

Sección C-C

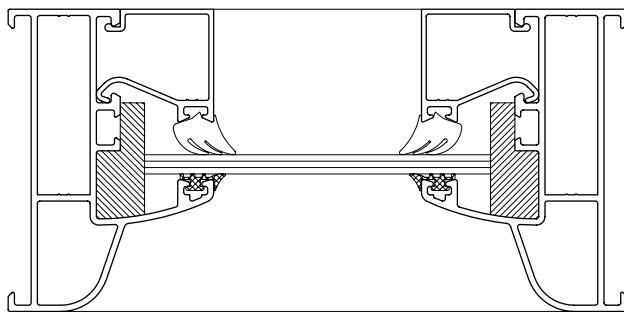

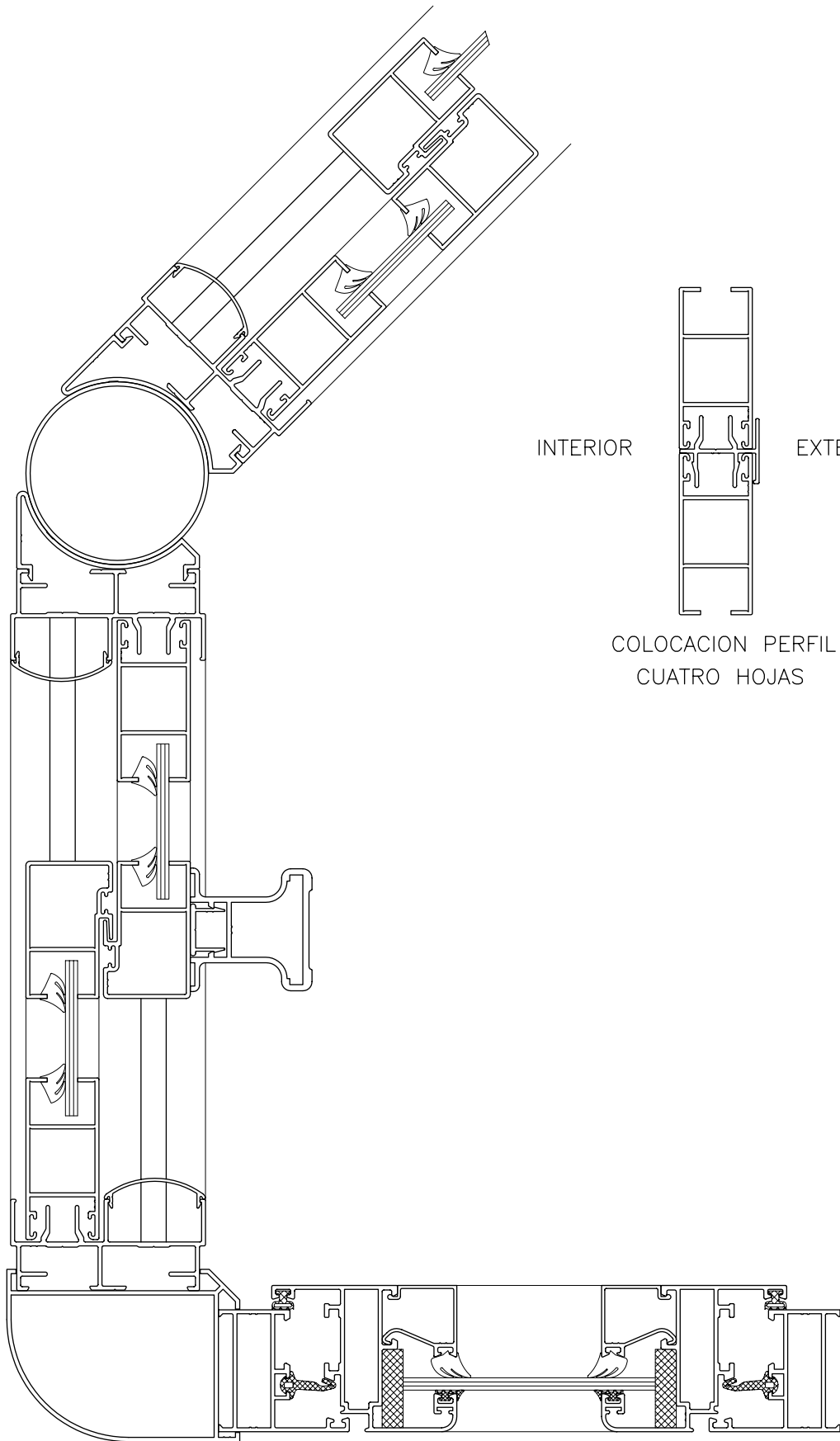



VENTANA DOS HOJAS

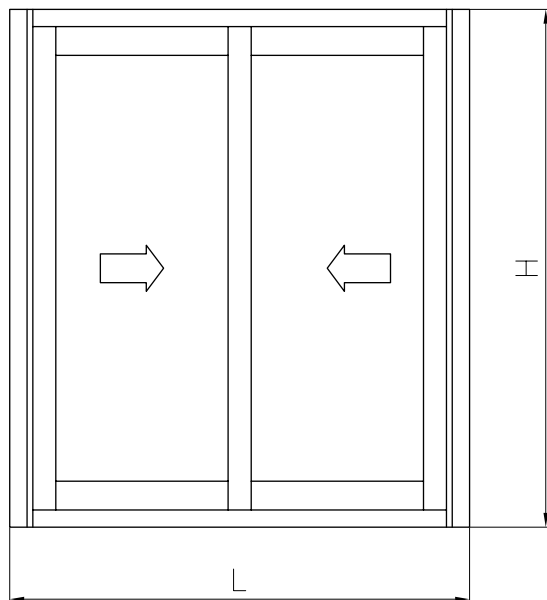

$$\text{Ancho} = \frac{L}{2} - 74$$

$$\text{Alto} = H - 134$$

VENTANA TRES HOJAS

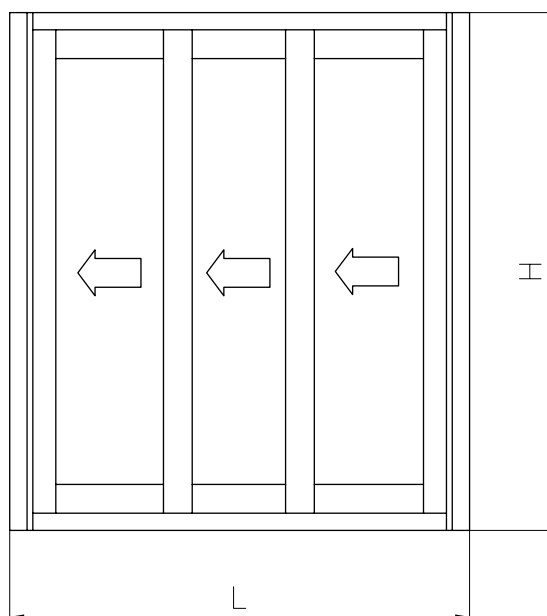

$$\text{Ancho Hoja Central} = \frac{L}{3} - 61$$

$$\text{Ancho Hojas Laterales} = \frac{L}{3} - 54$$

$$\text{Alto} = H - 134$$



VENTANA CUATRO HOJAS

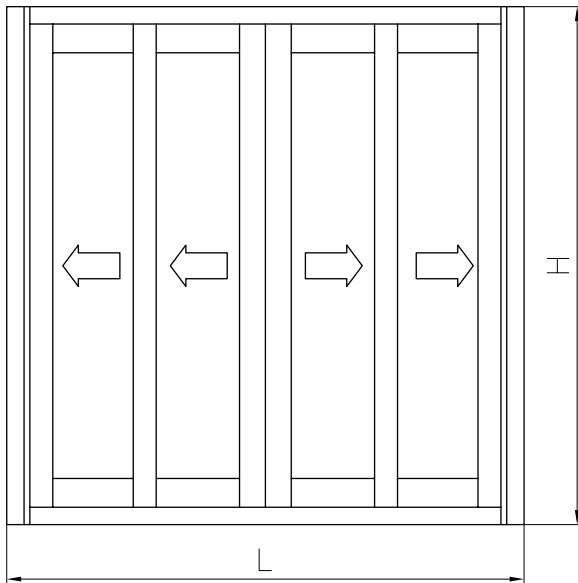

$$\text{Ancho} = \frac{L}{4} - 65$$

$$\text{Alto} = H - 134$$

FIJO PERIMETRAL

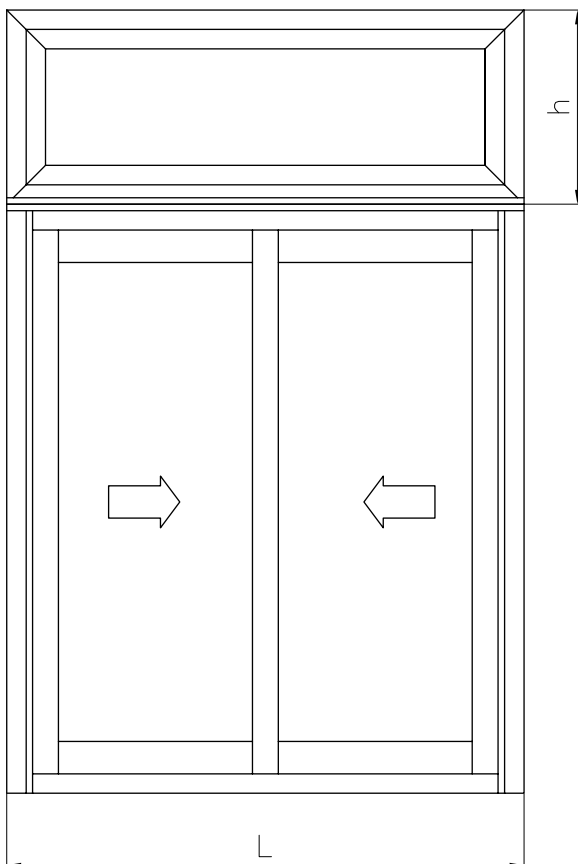

$$\text{Ancho} = L - 65$$

$$\text{Alto} = h - 65$$

FIJO TRADICIONAL SERIE 6000

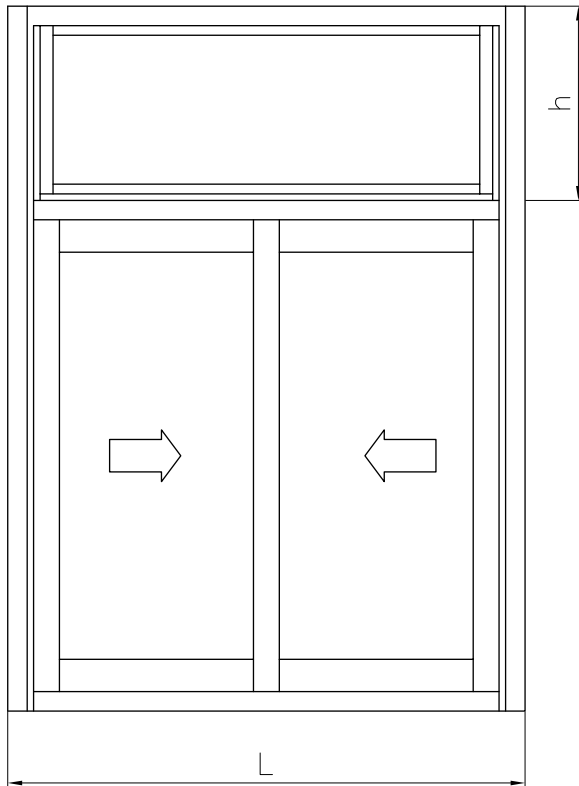

$$\text{Ancho} = L - 79$$

$$\text{Alto} = h - 36$$

FIJO TRADICIONAL CAMARA EUROPEA

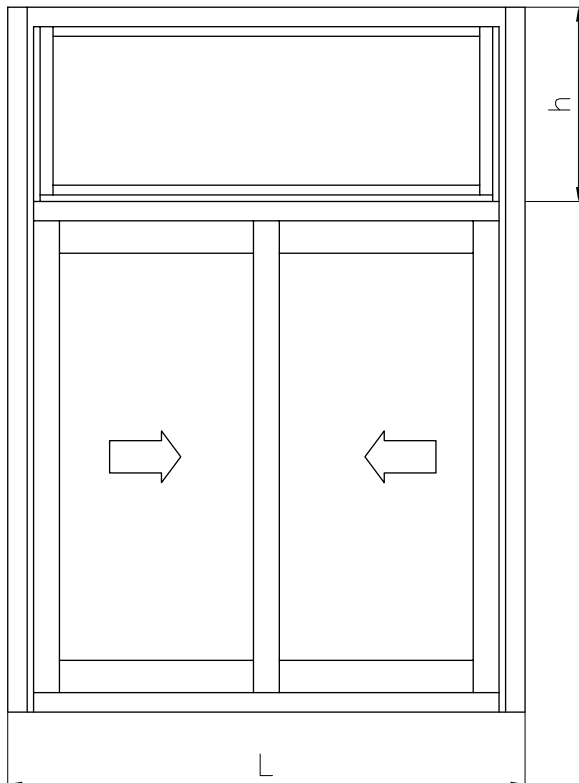

$$\text{Ancho} = L - 93$$

$$\text{Alto} = h - 43.6$$